

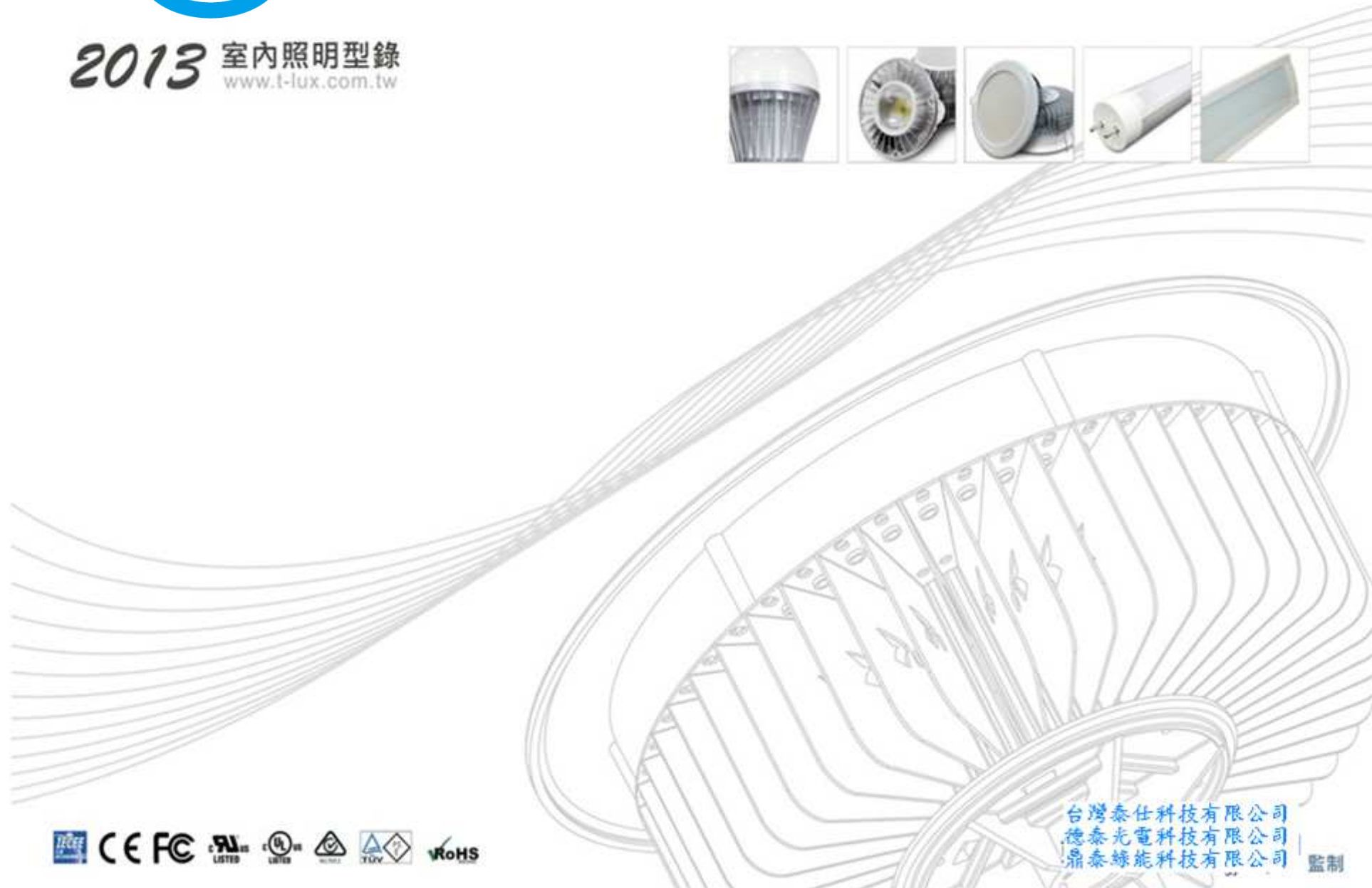

2013 室內照明型錄

www.t-lux.com.tw



台灣泰仕科技有限公司
德泰光電科技有限公司
鼎泰綠能科技有限公司 監制

Organization 組織架構圖

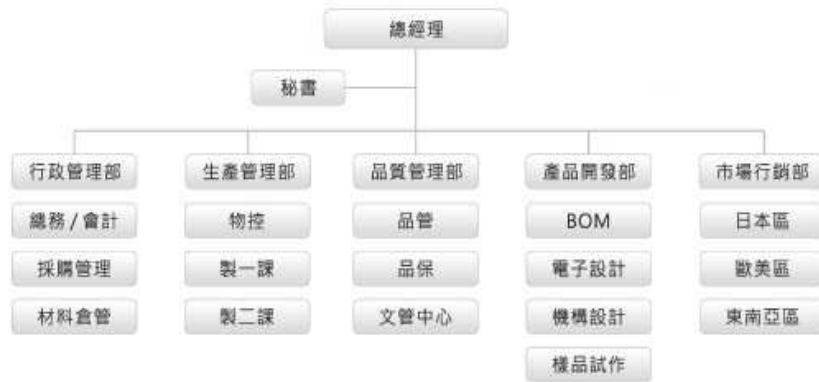

Managing Concept 經營理念

- F** ■ 專注經營「FOCUS」- 專注領域，有效生產。
- O** ■ 卓越品質「OUTSTANDING」- 追求卓越，精益求精。
- I** ■ 創新開發「INNOVATION」- 思維創新，成功實現。
- S** ■ 專業服務「SERVICE」- 引領需求，超越期待。

Patent & Certification 專利與認證



新型號 M 395096 號
LED燈管組及其轉接頭



新型號 M 396926 號
LED燈泡結構



新型號 M 396909 號
LED燈泡結構



新型號 M 396353 號
具有隱藏式變壓器之LED燈管



新型號 M 398308 號
可避免磁場干擾的LED燈管控制模組



新型號 M 398067 號
LED燈管用分離式模組



Certification

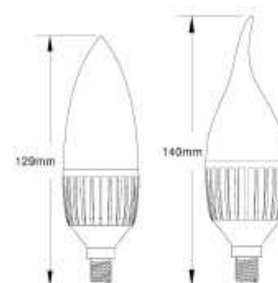

6W (E14) LED蠟燭燈系列
BU400614-C10N6x / BU400614-D10N6x



規格

工作電壓：100 ~ 240VAC，50-60HZ

功率：6W±10%。

功率因數：> 0.9

規格：E14

輸出亮度：400±10%LM (暖白)

輸出亮度：450±10%LM (冷白色)

色溫：2900±300K (暖白)

色溫：5400±700K (冷白色)

尺寸：40 X 129毫米

應用範圍：精品店，餐廳，飯店，酒吧，服飾店等裝飾性照明

訂單號

暖白：BU400614 C10N61，BU400614 D10N61

冷白色：BU400614 C10N61，BU400614 D10N61

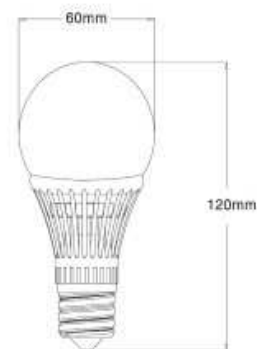

5W (E26) LED球泡燈系列
BU600526-013S6x



光學規格

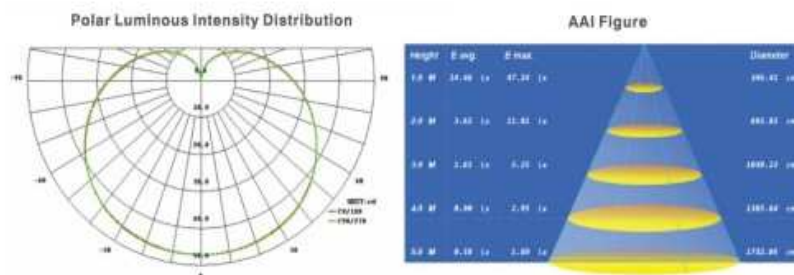

規格

工作電壓：100~240VAC，50-60HZ

功率：5W±10%。

功率因數：> 0.9

規格：E27 (E26)

輸出亮度：350±10%LM (暖白)

輸出亮度：400±10%LM (冷白色)

色溫：3000±200K (暖白)

色溫：5500±300K (冷白色)

尺寸：60x120毫米

適用範圍：走廊，庭院，樓梯間，公共場所...等區域性照明

訂單號

暖白： BU600527-013S61

冷白色： BU600527-013S65

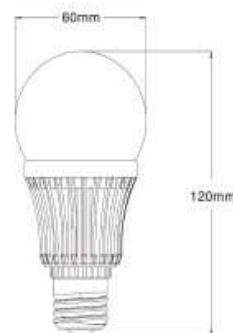

7W (E26) LED球泡燈系列 (IP-65)

BU600726-013S6x



光學規格

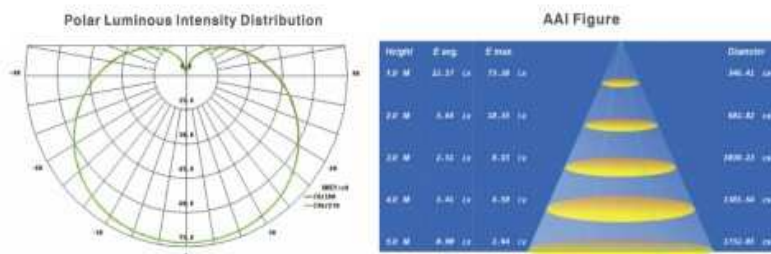

規格

工作電壓：100~240VAC，50-60HZ

消耗功率：7W±10%。

功率因數：> 0.9

規格：E27 (E26)

輸出亮度：550±10%LM (暖白)

輸出亮度：600±10%LM (冷白色)

色溫：3000±200K (暖白)

色溫：5500±300K (冷白色)

尺寸：60 x 120毫米

應用：庭院，景觀，戶外壁燈等防水型照明光源

訂單號

暖白：BU600727-013S61

冷白色：BU600727-013S65

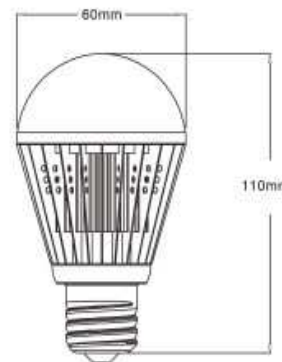

9W (E26) LED燈泡系列

BU600926-011N6x



光學規格

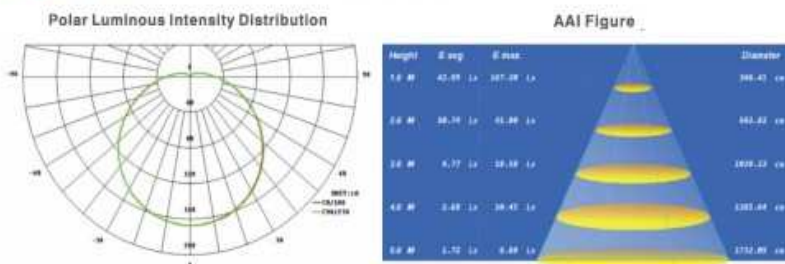

規格

工作電壓：100~240VAC，50-60HZ

功率：9W±10%。

功率因數：> 0.9

規格：E27 (E26)

輸出亮度：750±10%LM (暖白)

輸出亮度：800±10%LM (冷白色)

色溫：3000±200K (暖白)

色溫：5500±300K (冷白色)

尺寸：60 x 110毫米

應用範圍：大廳，玄關，臥室，書房，酒吧，辦公室等
照明

訂單號

暖白：BU600927-011N61

冷白色：BU600927-011N65

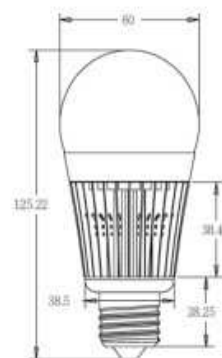

12W (E26) LED球泡燈系列
BU601226-013S6x



規格

工作電壓：100~240VAC，50-60HZ

消耗功率：12W±10%。

功率因數：> 0.9

規格：E27 (E26)

輸出亮度：950±10%LM (暖白)

輸出亮度：1800±10%LM (冷白色)

色溫：3000±200K (暖白)

色溫：5500±300K (冷白色)

尺寸：60 x 125毫米

應用範圍：大廳，玄關，臥室，書房，酒吧，辦公室等照明

光學規格

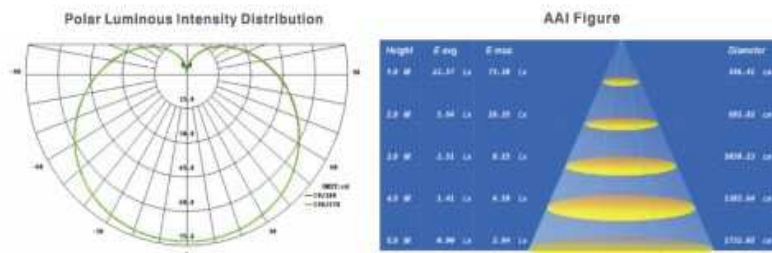

訂單號

暖白：BU600927-011N61

冷白色：BU600927-011N65

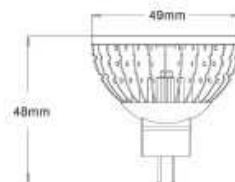

6W (GU5.3) LED MR-16系列
MR16G536-10AV2x



規格

工作電壓：100~240VAC

功率：6W±10%。

新舊交替：GU5.3

輸出亮度：400±10%LM (暖白)

輸出亮度：450±10%LM (冷白色)

色溫：2700±200K (暖白)

色溫：5700±300K (冷白色)

外形尺寸：49 x 48毫米

應用領域：餐廳，展示櫃，書廊，飯店，服飾店等聚光型照明

光學規格

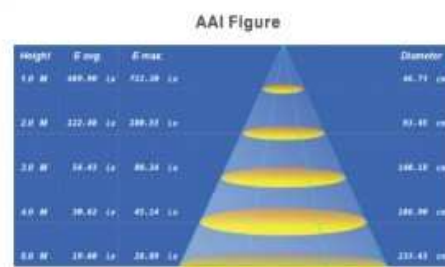
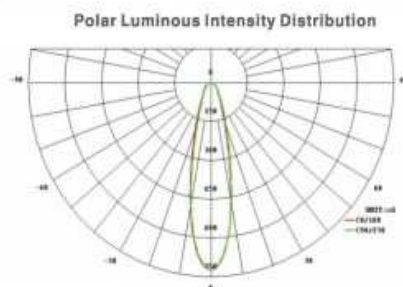

訂單號

暖白：MR16G53610AV21

冷白色：MR16G53610AV25



8W (GU5.3) LED MR-16系列
MR16G538-10AVNx



規格

- 工作電壓：100~240VAC
- 功率：8W±10%
- 新舊交替：GU5.3
- 輸出亮度：540±10%LM (暖白)
- 輸出亮度：600±10%LM (冷白色)
- 色溫：2700±200K (暖白)
- 色溫：5700±300K (冷白色)
- 外形尺寸：49 x 48毫米
- 應用領域：餐廳，展示櫃，書廊，飯店，服飾店等聚光型照明

光學規格

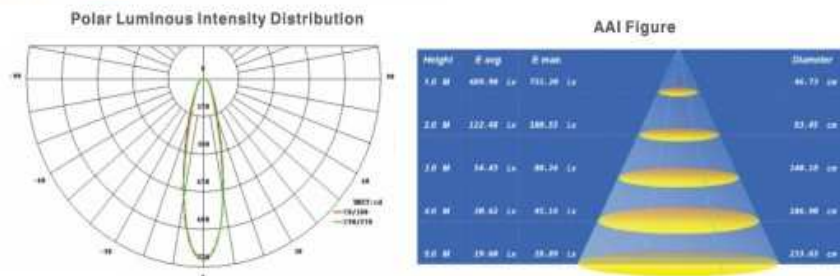

訂單號

- 暖白：MR16G53810AVN1
- 冷白色：MR16G53810AVN5

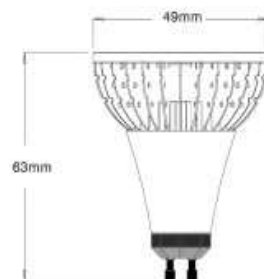

6W (GU10) LED MR-16系列
MR16G106-10xN6x



規格

工作電壓：230VAC，50Hz的

功率：6W±10%。

新舊交替：GU10

輸出亮度：400±10%LM (暖白)

輸出亮度：450±10%LM (冷白色)

色溫：2700±200K (暖白)

色溫：5700±300K (冷白色)

外形尺寸：49 x 48毫米

應用領域：餐廳，展示櫃，書廊，飯店，服飾店等聚光型照明

光學規格

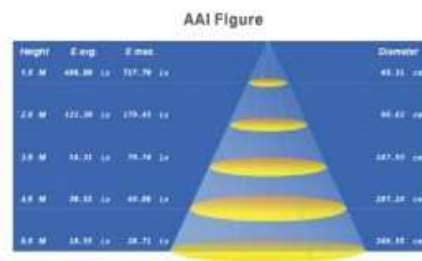
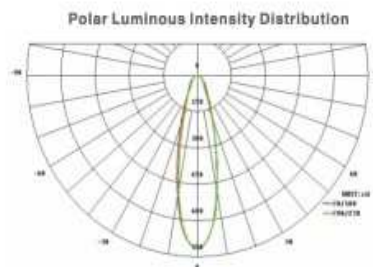

訂單號

暖白：MR16G53810AVN61

冷白色：MR16G53810AVN65



6W (E11) LED MR-16系列
MR16E116-10AN6x



規格

- 工作電壓：100VAC，50Hz的
- 功率：6W±10%。
- 新舊交替：E11
- 輸出亮度：400±10%LM (暖白)
- 輸出亮度：450±10%LM (冷白色)
- 色溫：2700±200K (暖白)
- 色溫：5700±300K (冷白色)
- 外形尺寸：49 x 66毫米
- 應用領域：餐廳，展示櫃，書廊，飯店，服飾店等聚光型照明

光學規格

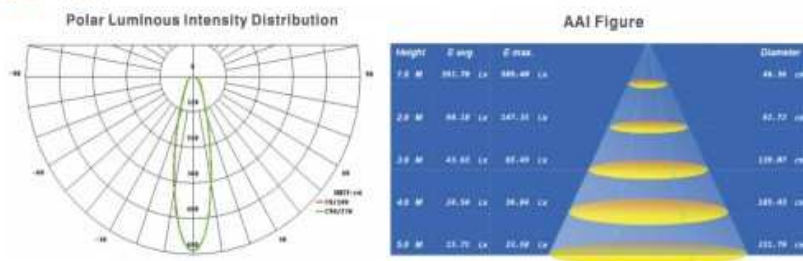

訂單號

- 暖白：MR16E11610AN61
- 冷白色：MR16E11610AN65

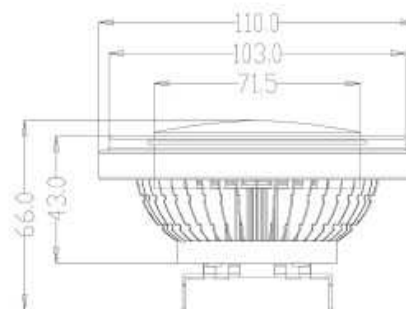

12W (G53) LED AR111系列

MR40AR12-00AN6x



規格

工作電壓：100~240VAC，50~60HZ

消耗功率：12W±10%。

功率因數：> 0.9

新舊交替：G53

輸出亮度：850±10%LM (暖白)

輸出亮度：950±10%LM (冷白色)

色溫：2700±200K (暖白)

色溫：5700±300K (冷白色)

外形尺寸：110 x 66毫米

應用領域：餐廳，展示櫃，書廊，飯店，服飾店等聚光型照明

光學規格

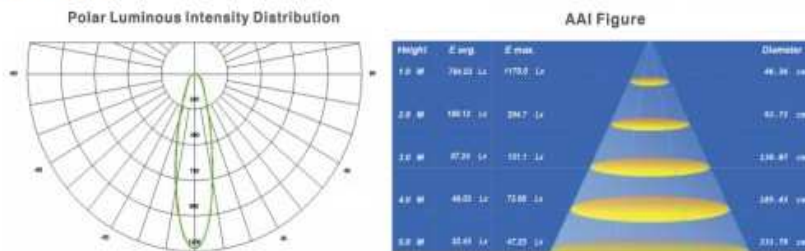

訂單號

暖白：MR40ES1200AN61

冷白色：MR40ES1200AN65

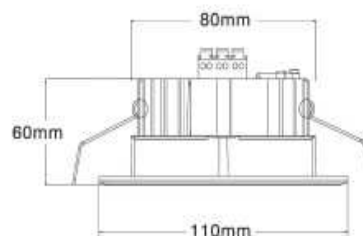

8W (2.5 ") 嵌燈系列

GS25DL08-001N6x



光學規格

Polar Luminous Intensity Distribution

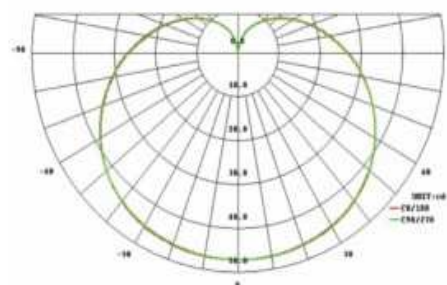

AAI Figure

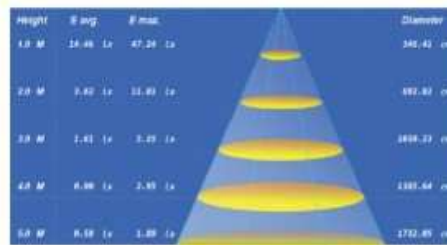

規格

工作電壓：100~240VAC，50~60HZ

功率：8W±10%。

功率因數：> 0.9

凹孔:75-90毫米

輸出亮度：500±10%LM (暖白)

輸出亮度：550±10%LM (冷白色)

色溫：3000±200K (暖白)

色溫：6000±300K (冷白色)

外形尺寸：110×80×60毫米

應用範圍：住宅大樓，辦公室，走廊，商店...等泛光型光源

訂單號

暖白：GS25 DL08-001N62

冷白色：GS25 DL08-001N66

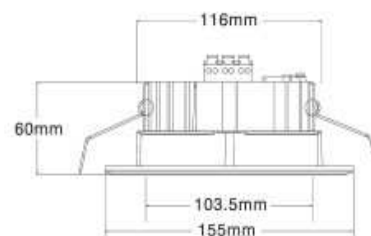

12W (4.0 ") 嵌燈系列

GS40DL12-001S6x



規格

工作電壓：100~240VAC，50~60HZ

消耗功率：12W±10%。

功率因數：> 0.9

凹孔：120-125毫米

輸出亮度：750±10%LM (暖白)

輸出亮度：800±10%LM (冷白色)

色溫：3000±200K (暖白)

色溫：6000±300K (冷白色)

外形尺寸：155×116×60毫米

應用範圍：室內照明設備

光學規格

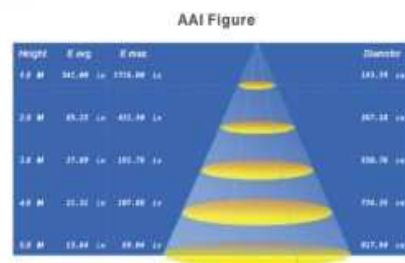
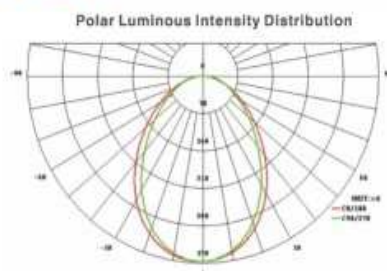

訂單號

暖白：GS40 DL12-001S62

冷白色：GS40 DL12-001S66

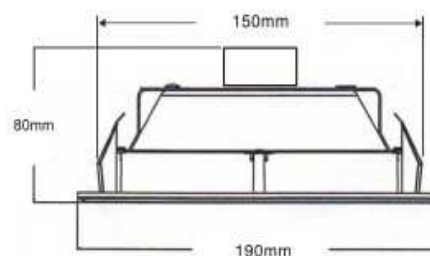

12W (6.0 ") 嵌燈系列
GS60SL12-001VAx



規格

- 工作電壓：100~240VAC，50~60HZ
- 消耗功率：12W±10%。
- 功率因數：> 0.9
- 凹孔:155-175毫米
- 輸出亮度：700±10%LM (暖白)
- 輸出亮度：750±10%LM (冷白色)
- 色溫：3000±200K (暖白)
- 色溫：5700±300K (冷白色)
- 外形尺寸：190×150×60毫米
- 應用範圍：住宅大樓，辦公室，走廊，商店...等泛光型光源

訂單號

- 暖白：GS60 SL12-001VA1
- 冷白色：GS60 SL12-001VA5

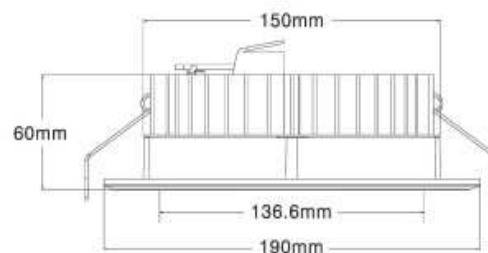

15W (6.0 ") 嵌燈系列

GS60DL15-001S6x



光學規格

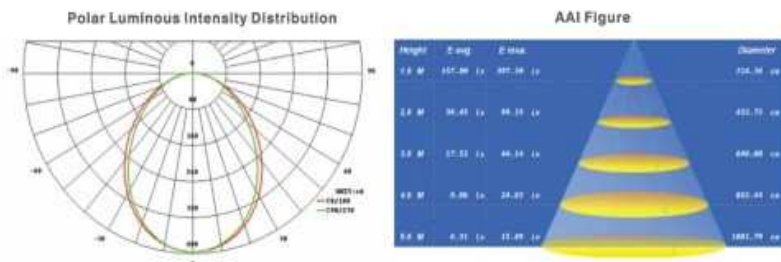

規格

工作電壓：100~240VAC，50~60HZ

消耗功率：15W±10%

功率因數：> 0.9

凹孔:155-175毫米

輸出亮度：900±10%LM (暖白)

輸出亮度：1000±10%LM (冷白色)

色溫：3000±200K (暖白)

色溫：6000±300K (冷白色)

外形尺寸：190×150×60毫米

應用範圍：住宅大樓，辦公室，走廊，商店...等泛光型光源

訂單號

暖白：GS60 DL15-001S62

冷白色：GS60 DL15-001S66

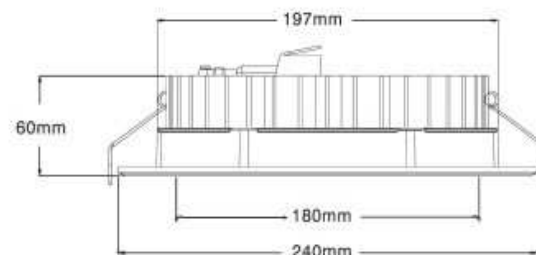

25W (8.0 ") 嵌燈系列

GS80DL25-001S6x

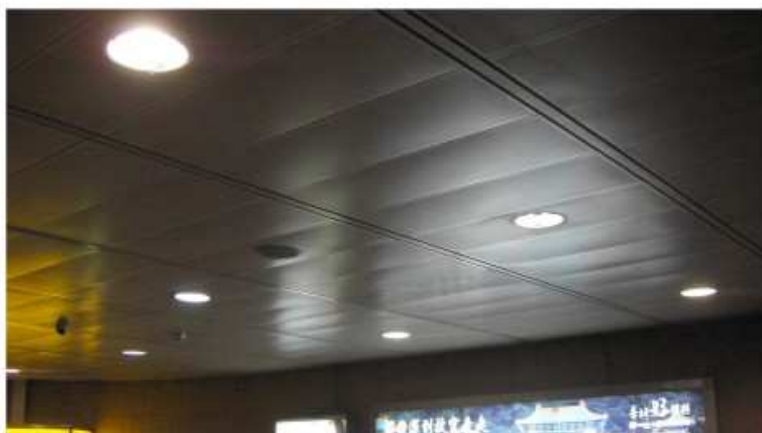

規格

工作電壓：100~240VAC，50~60HZ

功率：25W±10%。

功率因數：> 0.9

凹孔:200-220毫米

輸出亮度：2000±10%LM (暖白)

輸出亮度：2000±10%LM (冷白色)

色溫：3000±200K (暖白)

色溫：6000±300K (冷白色)

尺寸：240x197x60毫米

應用範圍：住宅大樓，辦公室，走廊，商店...等泛光型光源

光學規格

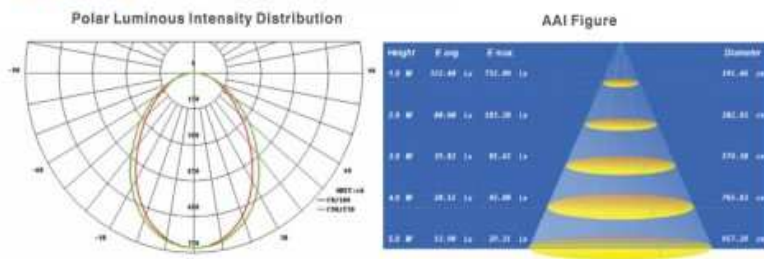

訂單號

暖白：GS80 DL25-001S62

冷白色：GS80 DL25-001S66

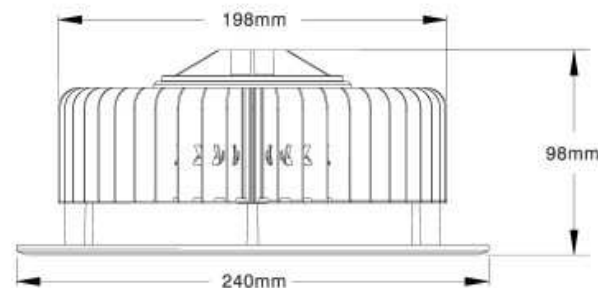

40W (8.0 ") 嵌燈系列

GS80DL40-001S6x



規格

工作電壓：100~240VAC，50~60HZ

功率：40W±10%。

功率因數：> 0.9

凹孔:200-220毫米

輸出亮度：3200±10%LM (暖白)

輸出亮度：3500±10%LM (冷白色)

色溫：3000±200K (暖白)

色溫：6000±300K (冷白色)

尺寸：240 x 198 x 98毫米

應用：挑高型大堂，辦公大樓，商場，走廊等泛光型光源

光學規格

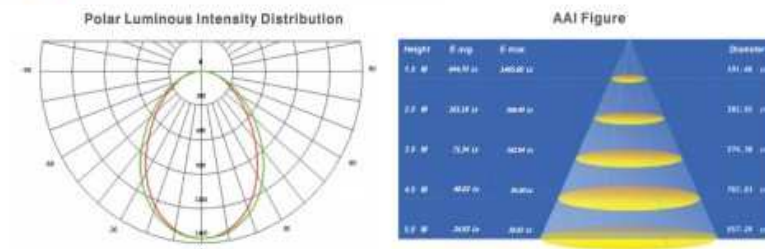

訂單號

暖白：GS80 DL40-001S62

冷白色：GS80 DL40-001S66

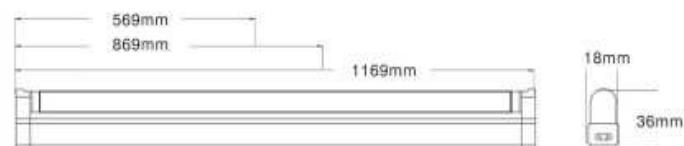

T5H (G5) LED燈管系列

FT5Hxxx-101S6x



光學規格

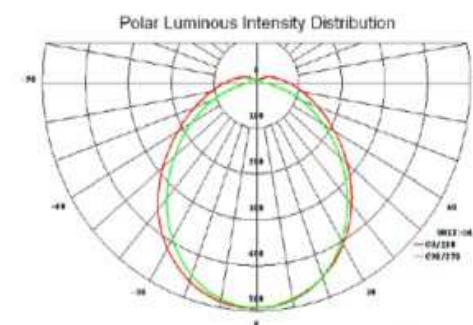

規格

Order No.	Voltage	Luminance	Wattage	Color Temp.	C.R.I	Socket
FT5H0549-101N61	100-240V	800Lm	10	3000±200K	>70	G5
FT5H0549-101N65	100-240V	850Lm	10	6000±300K	>70	G5
FT5H0849-101N61	100-240V	1200Lm	15	3000±200K	>70	G5
FT5H0849-101N65	100-240V	1300Lm	15	6000±300K	>70	G5
FT5H1149-101N61	100-240V	1600Lm	20	3000±200K	>70	G5
FT5H1149-101N65	100-240V	1700Lm	20	6000±300K	>70	G5

訂單號

暖白：FT5H0549 - 101N61, FT5H0849 - 101N61, FT5H1149 - 101N61
冷白色：FT5H0549 - 101N65, FT5H0849 - 101N65, FT5H1149 - 101N65

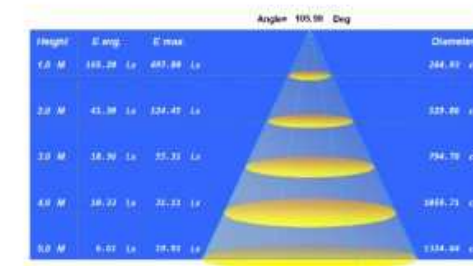

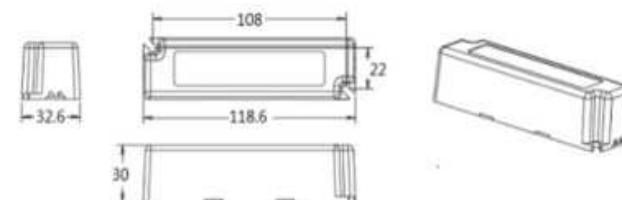

T8H (G13) LED燈管系列

FT8Hxxxx-LB1VAx



規格

Order No.	Voltage	Luminance	Wattage	Color Temp.	C.R.I	Socket
FT8H0580-LB1VA1	100-240V	1000Lm	12	3000±200K	>70	G13
FT8H0580-LB1VA5	100-240V	1100Lm	12	6000±300K	>70	G13
FT8H1198-LB1VA1	100-240V	2100Lm	25	3000±200K	>70	G13
FT8H1198-LB1VA5	100-240V	2200Lm	25	6000±300K	>70	G13

訂單號

暖白：FT8H0580-LB1VA1，FT8H1198-LB1VA1

冷白色：FT8H0580-LB1VA5，FT8H1198-LBVA5



光學規格

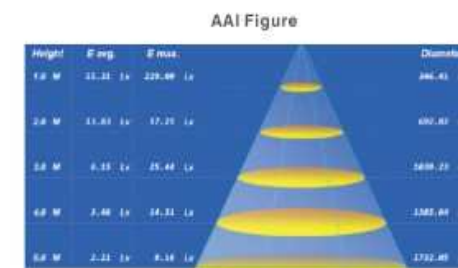
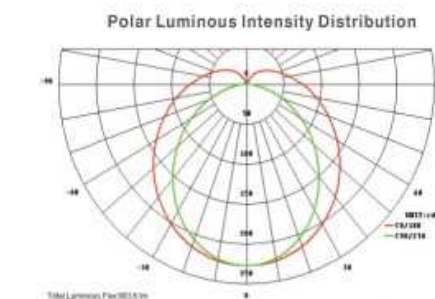

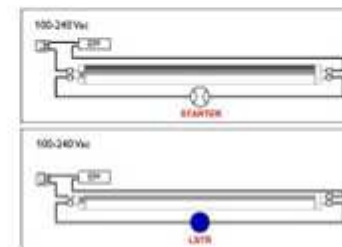
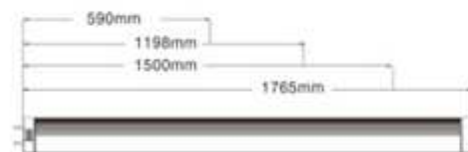
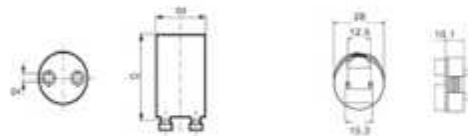

T9A (G13) LED燈管系列

FT9Axxx-101S6x



規格

Order No.	Voltage	Luminance	Wattage	Color Temp.	C.R.I	Socket
FT9A0590-101R62	100-240V	800Lm	10	3000±200K	>70	G13
FT9A0590-101R66	100-240V	900Lm	10	6000±300K	>70	G13
FT9A1198-101R62	100-240V	1700Lm	20	3000±200K	>70	G13
FT9A1198-101R66	100-240V	1800Lm	20	6000±300K	>70	G13
FT9A1500-101R62	100-240V	2100Lm	24	3000±200K	>70	G13
FT9A1500-101R66	100-240V	2200Lm	24	6000±300K	>70	G13
FT9A1765-101R62	100-240V	2600Lm	30	3000±200K	>70	G13
FT9A1765-101R66	100-240V	2700Lm	30	6000±300K	>70	G13



光學規格

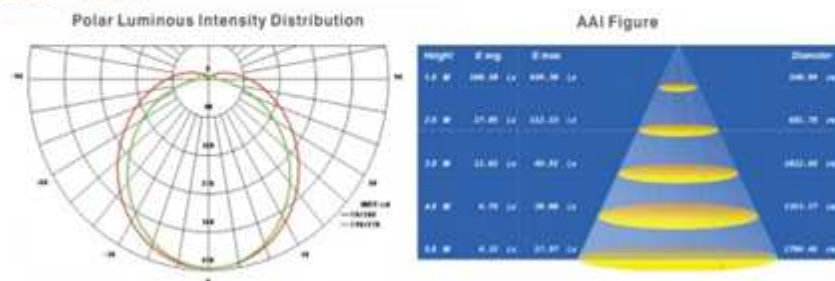

訂單號

暖白： FT9A0590-101R62, FT9A1198-101R62
 FT9A1500-101R62, FT9A1765-101R62
 冷白色： FT9A0590-101R66, FT9A1198-101R66
 FT9A1500-101R66, FT9A1765-101R66

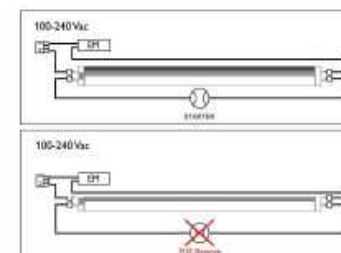
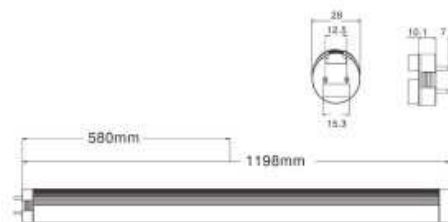

T9B (G13) LED燈管系列

FT9Bxxxx-101S6x



規格

Order No.	Voltage	Luminance	Wattage	Color Temp.	C.R.I	Socket
FT9B0580-101S62	100-240V	800Lm	10	3000±200K	>70	G13
FT9B0580-101S66	100-240V	900Lm	10	6000±300K	>70	G13
FT9B1198-101S62	100-240V	1700Lm	20	3000±200K	>70	G13
FT9B1198-101S66	100-240V	1800Lm	20	6000±300K	>70	G13

訂單號

暖白：FT9B0580-101S62, FT9B1198-101S62

冷白色：FT9B0580-101S66, FT9B1198-101S66

光學規格

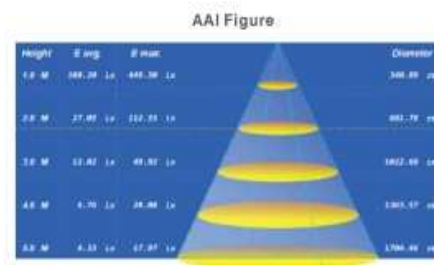
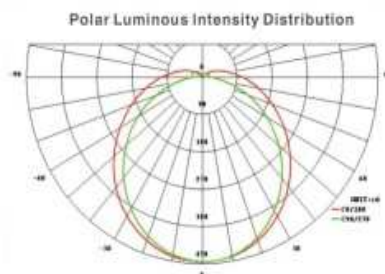

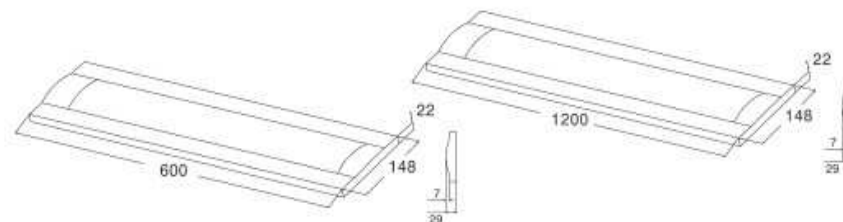

22W弧形平板燈管 / 40W弧形平板燈管

BTMH6014-001S6x / BTMH1214-001S6x



規格

Order No.	Voltage	Wattage	Color Temp.	C.R.I	Socket
BTMH6014-001S61	100-240V	22	3000±200K	>70	2FT
BTMH6014-001S65	100-240V	22	5700±300K	>70	2FT
BTMH1214-001S61	100-240V	40	3000±200K	>70	4FT
BTMH1214-001S65	100-240V	40	5700±300K	>70	4FT

訂單號

暖白：BTMH6014-001S61,BTMH6014-001S65

冷白色：BTMH1214-001S61,BTMH1214-001S65

光學規格

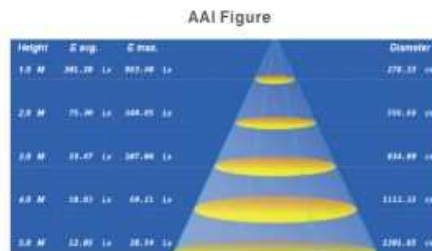
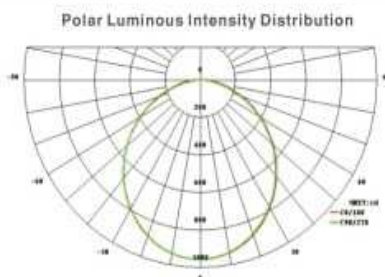

應用範圍

辦公室, 會議廳, 商業, 大樓, 展示間... 商用照明
 Offices, conference room, business, building, showroom...
 commercial lighting

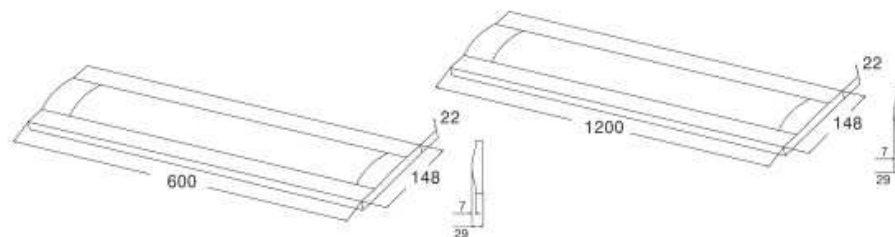

22W弧形平板燈管 / 40W弧形平板燈管

CTMH6014-001S6x / CTMH1214-001S6x



規格

Order No.	Voltage	Wattage	Color Temp.	C.R.I	Socket
CTMH6014-001S61	100-240V	22	3000±200K	>70	2FT
CTMH6014-001S65	100-240V	22	5700±300K	>70	2FT
CTMH1214-001S61	100-240V	40	3000±200K	>70	4FT
CTMH1214-001S65	100-240V	40	5700±300K	>70	4FT

訂單號

暖白：CTMH6014-001S61,CTMH6014-001S65

冷白色：CTMH1214-001S61,CTMH1214-001S65

光學規格

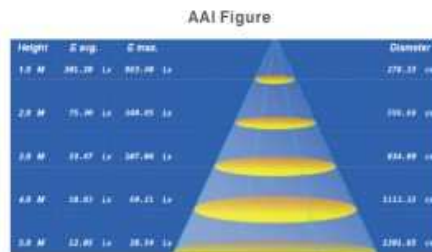
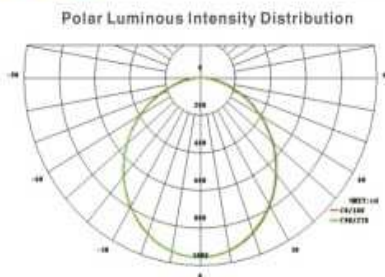

應用範圍

辦公室, 會議廳, 商業, 大樓, 展示間... 商用照明
Offices, conference room, business, building, showroom...
commercial lighting

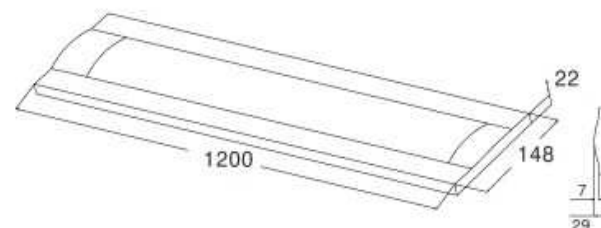

40W吊燈系列

DTMH1214-001S6x



規格

工作電壓：100~240VAC，50-60HZ

功率：40W±10%。

功率因數：> 0.9

輸出亮度：2900±10%LM (暖白)

輸出亮度：3200±10%LM (冷白色)

色溫：3000±200K (暖白)

色溫：5700±300K (冷白色)

外形尺寸：1200×147×30毫米

應用：辦公室，會議廳，商業，大樓，展示間...等商業照明

訂單號

暖白：DTMH1214-001S61

冷白色：DTMH1214-001S65

光學規格

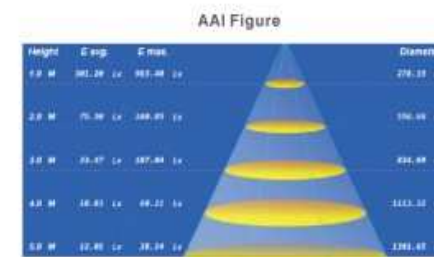
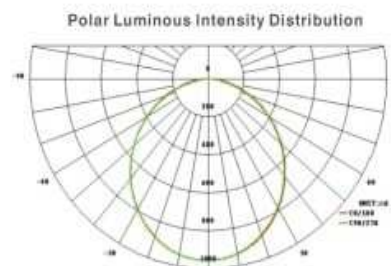

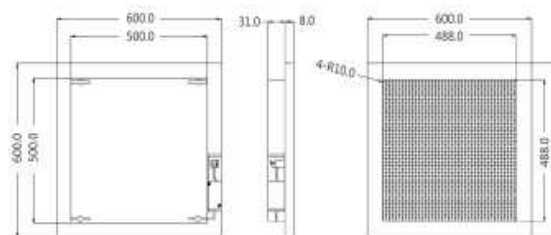

40W的天花板T-BAR系列

BTMH6060-004S6x



規格

工作電壓：100~240VAC，50-60HZ

功率：40W±10%。

功率因數：> 0.9

輸出亮度：3200±10%LM (暖白)

輸出亮度：3500±10%LM (冷白色)

色溫：3000±200K (暖白)

色溫：5700±300K (冷白色)

外形尺寸：600×600×36毫米

應用：辦公室，會議廳，商業，大樓，展示間...等商業照明

光學規格

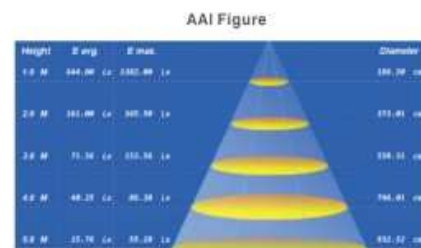
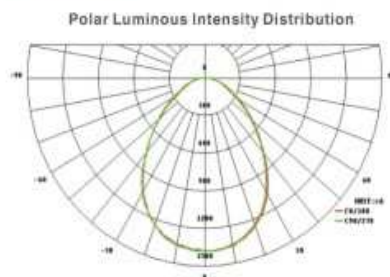

訂單號

暖白：BTMH6060的-004S61

冷色白：BTMH6060-004S65

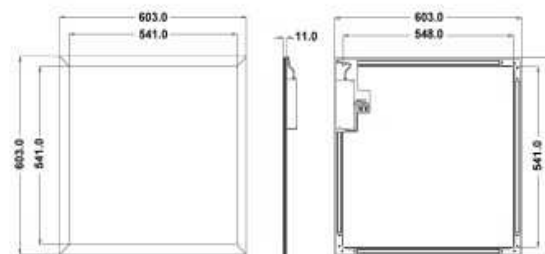
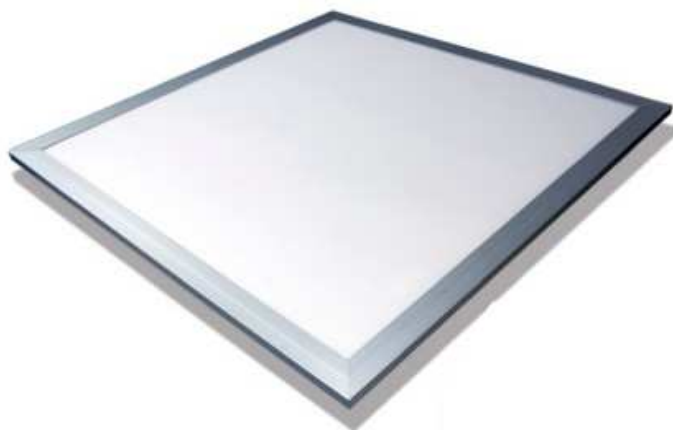

48W的T-BACK-LIGHT BAR系列

BTLH6060-001S6x



規格

工作電壓：100~240VAC，50-60HZ

消耗功率：48W±10%。

功率因數：> 0.9

輸出亮度：3500±10%LM (暖白)

輸出亮度：3800±10%LM (冷白色)

色溫：3000±200K (暖白)

色溫：5700±300K (冷白色)

外形尺寸：600×600×13毫米

應用：辦公室，會議廳，商業，大樓，展示間...等商業照明

光學規格

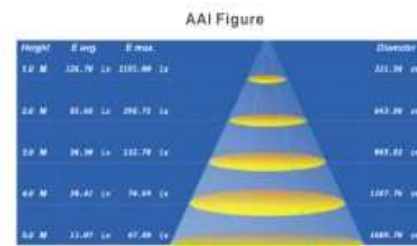
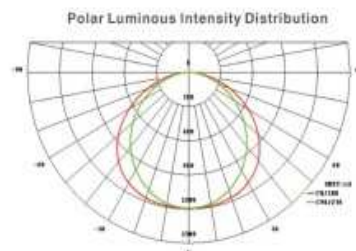

訂單號

暖白：BTLH6060的-001S63

冷白色：BTLH6060-001S65