

# Bulb-270C 球泡燈

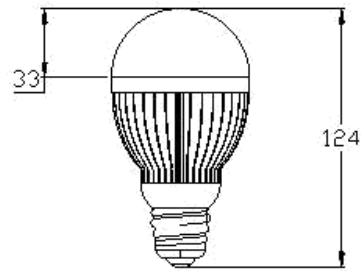
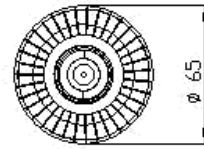

## 規格

輸入電壓：	AC100~240V
輸入瓦數：	14W
輸入頻率：	50/60HZ
亮度輸出：	860lm 1100lm
LED 光源：	Nichia (Made in Japan)
LED 數量：	14PCS
色 溫：	2700K 5700K
演 色 性：	>80 >70
調光與否：	Yes
燈泡可視角：	>270°符合美國能源之星標準

## 外觀

尺寸：	Φ65 × 124cm
重量：	125g

特徵：標準 E27 燈頭  
可替代螺旋燈管(麗晶燈)

產地：台灣製造(MIT)

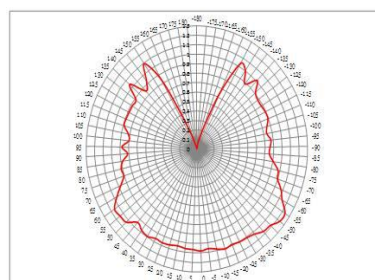
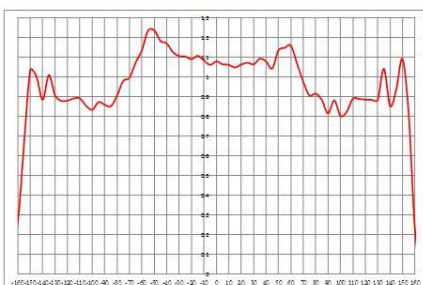

# Candle Light 蠟燭燈

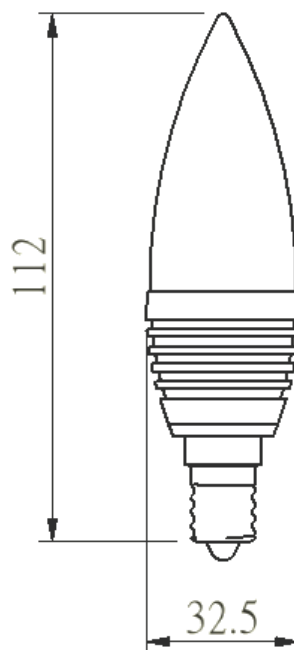

## 規格

輸入電壓：	AC100~240V
輸入瓦數：	4.5W
輸入頻率：	50/60HZ
亮度輸出：	280lm , 300lm
LED 光源：	Nichia (Made in Japan)
LED 數量：	4PCS
色 溫：	2800K , 5700K
演 色 性：	>80    >70
調 光：	NO
燈泡可視角：	>270°

## 基本尺寸與重量

尺寸：	Φ32.5 × 112cm
重量：	50g

特徵：標準 E14 燈頭

可替代 P 牌 28W 鹵素蠟燭燈或 40W 鎢絲蠟燭燈

產地：台灣製造(MIT)





MR16- Nichia 's LED



**APPLICATIONS**

- \* Entertainment lighting
- \* Architectural lighting
- \* City Beautification
- \* Landscape lighting

Illuminance at a distance

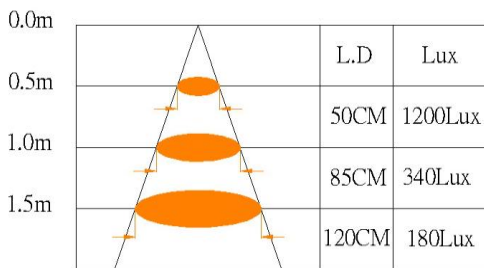

Light distribution curve

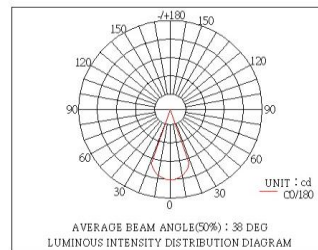

Input Voltage	Input Current	Power Consumption	Flux	Color Temperature	Beam Angle	CRI
AC90~240V50/60Hz For Outboard Transformer	350mA	5W max	280lm 300lm	2700K 5700K	38°	≧80 ≧70
AC/DC 12V For Electronic Transformer	360mA	5W max	280lm 300lm	2700K 5700K	38°	≧80 ≧70





PAR30-12W

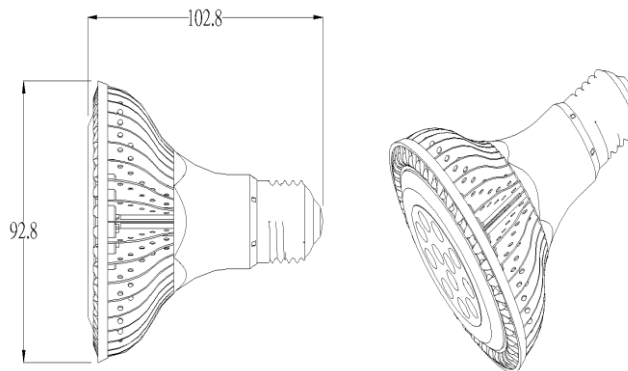

Illuminance at a distance

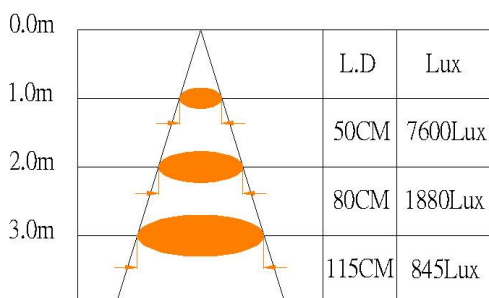

Light distribution curve

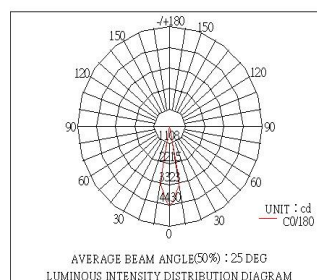

Input Voltage	Input Current	Power Consumption	Flux	Color Temperature	Beam Angle	CRI
AC100~240V	300mA	14W max	820lm 1100lm	2700K 5300K	38°	≥ 80





## AR111-M9

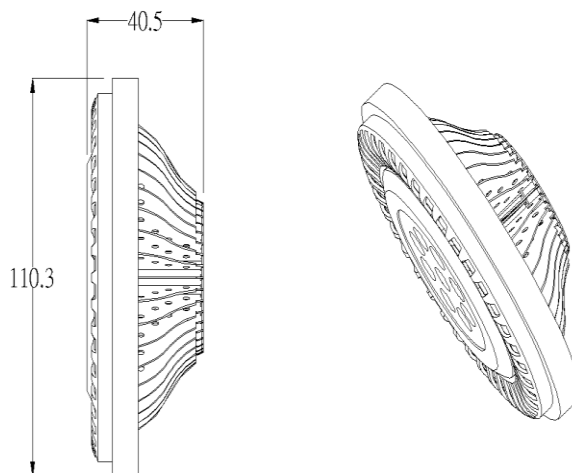

Illuminance at a distance

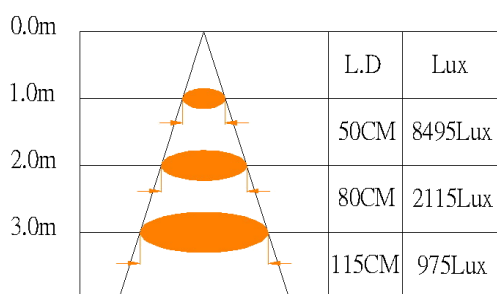

Light distribution curve

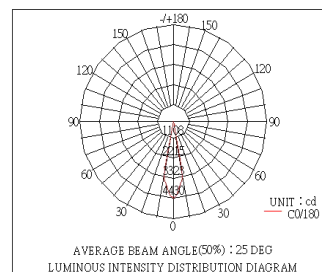

Input Voltage	Input Current	Power Consumption	Flux	Color Temperature	Beam Angle	CRI
AC100~240V	300mA	11W max	720lm 810lm	2700K 5300K	38°	≥ 80





AR111-M12

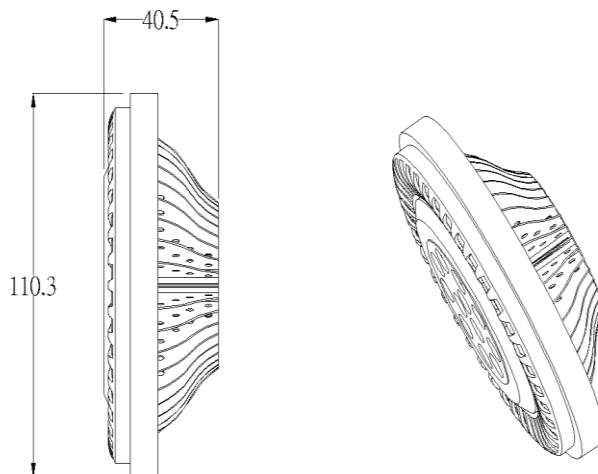

Illuminance at a distance

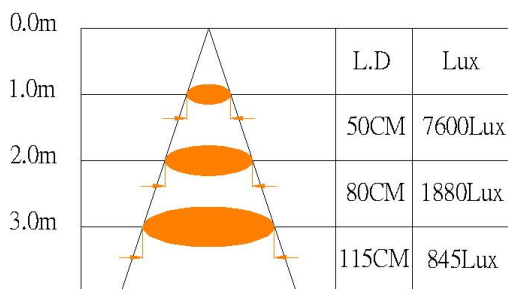

Light distribution curve

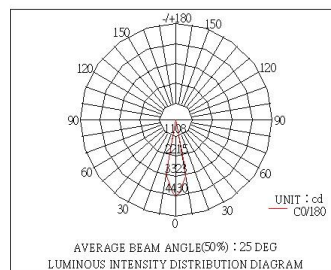

Input Voltage	Input Current	Power Consumption	Flux	Color Temperature	Beam Angle	CRI
AC100~240V	300mA	14W max	820lm 1100lm	2700K 5300K	38°	≥ 80

