

### Features

- **Provide Bi-direction Current**
  - **Sourcing or Sinking Current up to 3A**
- **1.25V/0.9V Output for DDR I/II Applications**
- **Fast Transient Response**
- **High Output Accuracy**
  - **±20mV over Load, VOUT Offset and Temperature**
- **Adjustable Output Voltage by External Resistors**
- **Current-Limit Protection**
- **On-Chip Thermal Shutdown**
- **Shutdown for Standby or Suspend Mode**
- **Simple SOP-8, SOP-8P with thermal pad, TO-252-5 and TO-263-5 Packages**
- **Lead Free and Green Devices Available (RoHS Compliant)**

### Applications

- **DDR I/II SDRAM Termination**
- **SSTL-2/3 Termination Voltage**
- **Applications Requiring the Regulator with Bi-directional 3A Current Capability**

### General Description

The APL5331 linear regulator is designed to provide a regulated voltage with bi-directional output current for DDR-SDRAM termination voltage. The APL5331 integrates two power transistors to source or sink current up to 3A. It also incorporates current-limit, thermal shut-down and shutdown control functions into a single chip.

The current-limit circuit limits the short-circuit current. The on-chip thermal shutdown provides protection against any combination of overload that would create excessive junction temperature. The output voltage of APL5331 tracks the voltage at VREF pin. A resistor divider connected to VIN, GND and VREF pins is used to provide a half voltage of VIN to VREF pin. In addition, an external ceramic capacitor and an open-drain transistor connected to VREF pin provide soft-start and shut-down control respectively. Pulling and holding the VREF voltage to 0V shuts off the output. The output of the APL5331 will be high impedance in shutdown condition.

### Pin Configuration

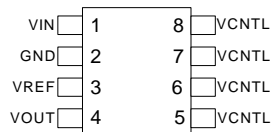

SOP-8 (Top View)

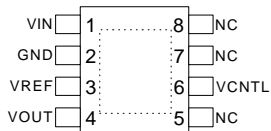

SOP-8P (Top View)

NC = No internal connection

 = Thermal Pad (connected to GND plane for better heat dissipation)

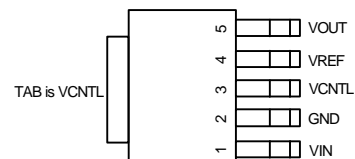

TO-252-5 (Top View)

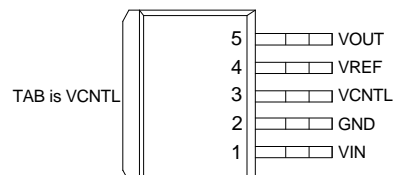

TO-263-5 (Top View)

ANPEC reserves the right to make changes to improve reliability or manufacturability without notice, and advise customers to obtain the latest version of relevant information to verify before placing orders.

## Ordering and Marking Information

<p>APL5331 <span style="font-family: monospace;">□□□-□□□</span></p> <div style="margin-left: 40px;"> <p>└─ Assembly Material</p> <p>└─ Handling Code</p> <p>└─ Temperature Range</p> <p>└─ Package Code</p> </div>	<p>Package Code</p> <p>K : SOP-8      KA : SOP-8P</p> <p>U5 : TO-252-5      G5 : TO-263-5</p> <p>Operating Ambient Temperature Range</p> <p>C : 0 to 70 °C</p> <p>Handling Code</p> <p>TR : Tape &amp; Reel</p> <p>Assembly Material</p> <p>L : Lead Free Device</p> <p>G : Halogen and Lead Free Device</p>
<p>APL5331 K :      <span style="border: 1px solid black; padding: 2px;">APL5331</span></p> <p>APL5331 KA :      <span style="border: 1px solid black; padding: 2px;">XXXXX</span></p>	<p>XXXXX - Date Code</p>
<p>APL5331 U5 :       <span style="border: 1px solid black; padding: 2px;">APL5331</span></p> <p>APL5331 G5 :      <span style="border: 1px solid black; padding: 2px;">XXXXX</span></p>	<p>XXXXX - Date Code</p>

Note: ANPEC lead-free products contain molding compounds/die attach materials and 100% matte tin plate termination finish; which are fully compliant with RoHS. ANPEC lead-free products meet or exceed the lead-free requirements of IPC/JEDEC J-STD-020C for MSL classification at lead-free peak reflow temperature. ANPEC defines "Green" to mean lead-free (RoHS compliant) and halogen free (Br or Cl does not exceed 900ppm by weight in homogeneous material and total of Br and Cl does not exceed 1500ppm by weight).

## Absolute Maximum Ratings

Symbol	Parameter	Rating	Unit
$V_{CNTL}$	VCNTL Supply Voltage, VCNTL to GND	-0.2 ~ 7	V
$V_{IN}$	VIN Supply Voltage, VIN to GND	-0.2 ~ 3.9	V
$P_D$	Power Dissipation	Internally Limited	W
$T_J$	Junction Temperature	150	°C
$T_{STG}$	Storage Temperature	-65 ~ 150	°C
$T_{SDR}$	Lead Soldering Temperature, 10 Seconds	260	°C

## Thermal Characteristics

Symbol	Parameter	Value	Unit
$\theta_{JA}$	Junction-to-Ambient Thermal Resistance in Free Air		
	SOP-8	75	°C/W
	SOP-8P	55	
	TO-252-5	42	
TO-263-5	34		
$\theta_{JC}$	Junction-to-Case Thermal Resistance		
	SOP-8	28	°C/W
	SOP-8P	20	
	TO-252-5	12	
TO-263-5	11		

Note :  $\theta_{JA}$  is measured with the component mounted on a high effective thermal conductivity test board in free air. The exposed pad of SOP-8P is soldered directly on the PCB.

## Recommended Operating Conditions

Symbol	Parameter	Range	Unit
$V_{CNTL}$	VCNTL Supply Voltage <sup>(Note 1)</sup>	3.1 ~ 6	V
$V_{IN}$	VIN Supply Voltage <sup>(Note 2)</sup>	1.2 ~ 3.5	V
$V_{OUT}$	VOUT Output Voltage <sup>(Note 3)</sup>	$V_{REF} \pm 0.02$	V
$I_{OUT}$	VOUT Output Current <sup>(Note 4,5)</sup>	-3 ~ +3	A
$T_J$	Junction Temperature	0 ~ 125	°C

Notes :

1. Please refer to the VCNTL-to-VIN Dropout Voltage in the "Typical Characteristics" section for the minimum supply voltage on VCNTL.
2. Please supply enough voltage to VIN for sourcing desired maximum output current. Please refer to the VIN. Dropout Voltage vs Output Current in the Typical Characteristics.
3. The VOUT is regulated to the  $V_{REF}$  with additional voltage offset and load regulation except over-load conditions.
4. The symbol "+" means the VOUT sources current to load; the symbol "-" means the VOUT sinks current to to GND.
5. The max.  $I_{OUT}$  varies with the  $T_J$  and the voltages of  $V_{IN}$ - $V_{OUT}$  and  $V_{OUT}$ . Please refer to the Typical Characteristics.

## Electrical Characteristics

Refer to the typical application circuit. These specifications apply over,  $V_{CNTL}=3.3V$ ,  $V_{IN}=2.5V/1.8V$ ,  $V_{REF}=0.5V_{IN}$  and  $T_A = 0$  to 70°C, unless otherwise specified. Typical values refer to  $T_A = 25^\circ C$ .

Symbol	Parameter	Test Conditions	APL5331			Unit
			Min	Typ	Max	
<b>OUTPUT VOLTAGE</b>						
$V_{OUT}$	VOUT Output Voltage	$I_{OUT} = 0A$		$V_{REF}$		V
	System Accuracy	Over temperature, VOUT offset, and load regulation	-20		20	mV
$V_{OS}$	VOUT Offset Voltage ( $V_{OUT}-V_{REF}$ )	$I_{OUT} = +10mA$	-15	-8		mV
		$I_{OUT} = -10mA$		6	14	
	Load Regulation	$I_{OUT} = +10mA$ to +3A	-8	-3		mV
		$I_{OUT} = -10mA$ to -3A		1	6	
<b>PROTECTION</b>						
$I_{LIM}$	Current Limit	Sourcing Current $T_J = 25^\circ C$ ( $V_{IN} = 2.5V$ ) $T_J = 125^\circ C$	+3.3	+3.6 +3.1		A
		Sourcing Current $T_J = 25^\circ C$ ( $V_{IN} = 2.5V$ ) $T_J = 125^\circ C$	-3.3	-3.6 -3.1		
		Sourcing Current $T_J = 25^\circ C$ ( $V_{IN} = 1.8V$ ) $T_J = 125^\circ C$	+2.9	+3.2 +2.6		
		Sourcing Current $T_J = 25^\circ C$ ( $V_{IN} = 1.8V$ ) $T_J = 125^\circ C$	-2.9	-3.2 -2.6		
$T_{SD}$	Thermal Shutdown Temperature	Rising $T_J$		183		°C
	Thermal Shutdown Hysteresis			42		°C

## Electrical Characteristics (Cont.)

Refer to the typical application circuit. These specifications apply over,  $V_{CNTL}=3.3V$ ,  $V_{IN}=2.5V/1.8V$ ,  $V_{REF}=0.5V_{IN}$  and  $T_A = 0$  to  $70^{\circ}C$ , unless otherwise specified. Typical values refer to  $T_A = 25^{\circ}C$ .

Symbol	Parameter	Test Conditions	APL5331			Unit
			Min	Typ	Max	
<b>INPUT CURRENT</b>						
$I_{CNTL}$	VCNTL Supply Current	$I_{OUT} = 0A$	2	3.9	6	mA
		$I_{OUT} = \pm 3A$ (Normal Operation)		50	110	
		$V_{REF} = GND$ (Shutdown)		2.0		
$I_{VREF}$	VREF Bias Current (The current flows out of VREF)	$V_{REF} = 1.25V/0.9V$ (Normal Operation)		200	500	nA
		$V_{REF} = GND$ (Shutdown)		20	40	$\mu A$
<b>SHUTDOWN CONTROL</b>						
	Shutdown Threshold Voltage		0.2	0.35	0.65	V

Typical Operating Characteristics

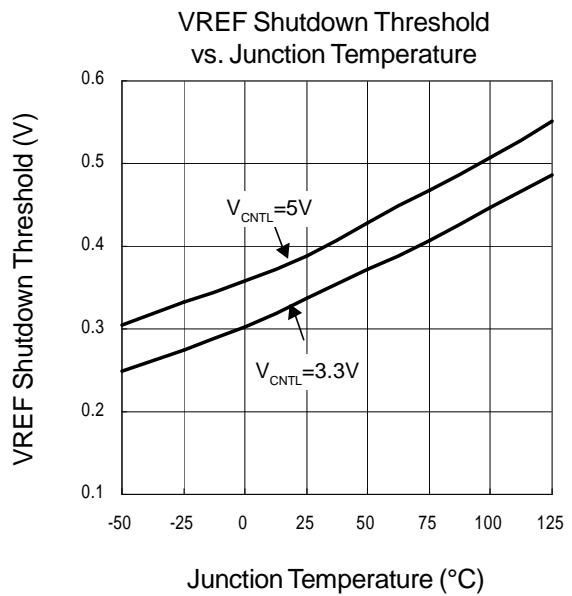
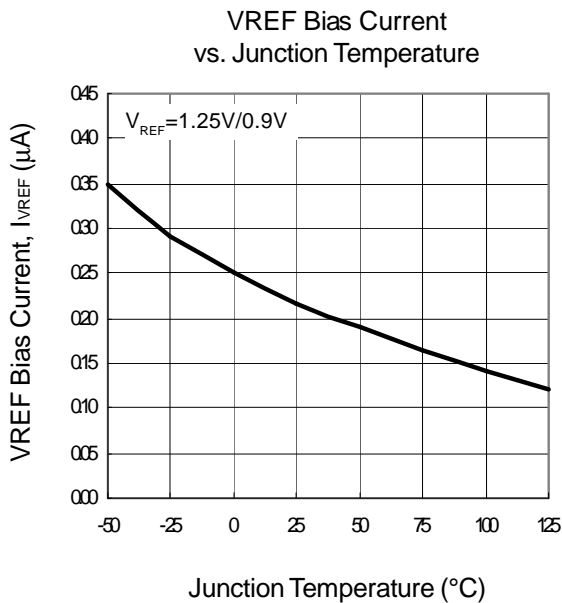
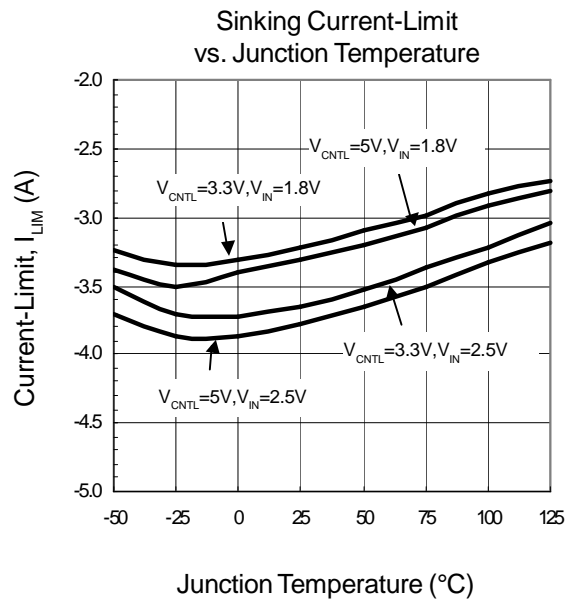
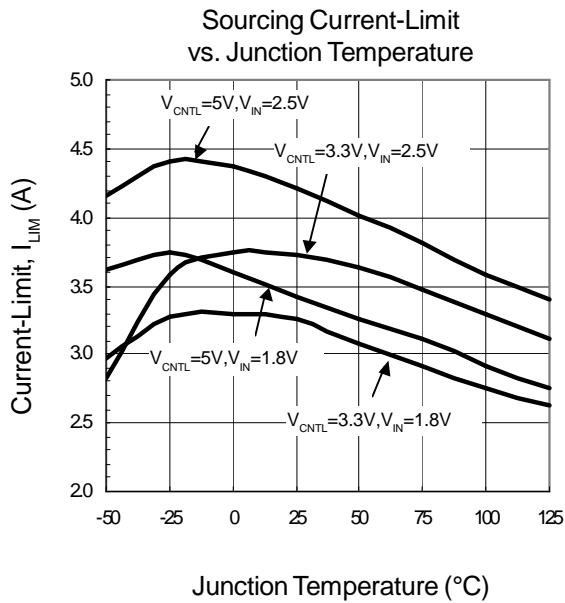

Typical Operating Characteristics (Cont.)

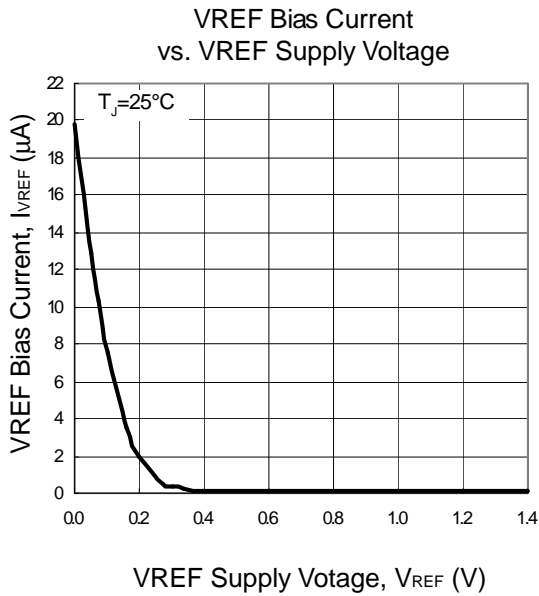
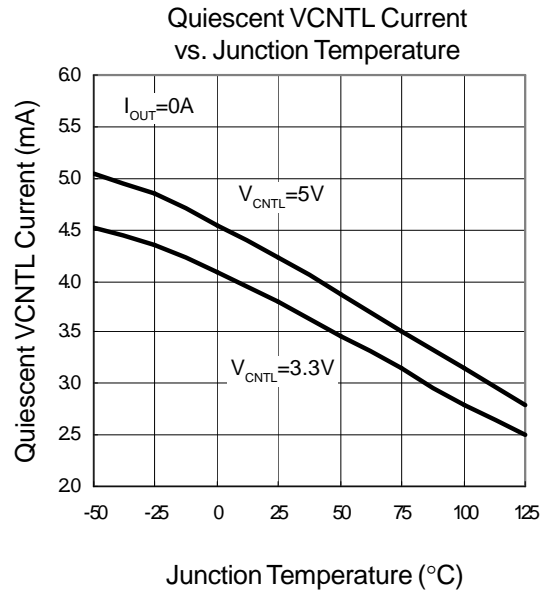
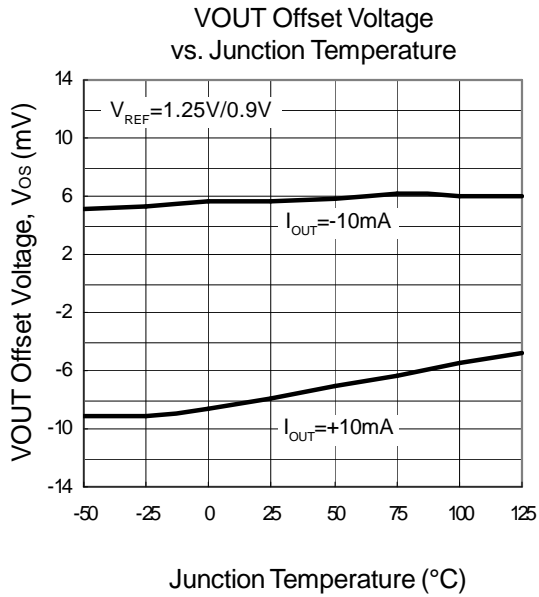

Typical Operating Characteristics (Cont.)

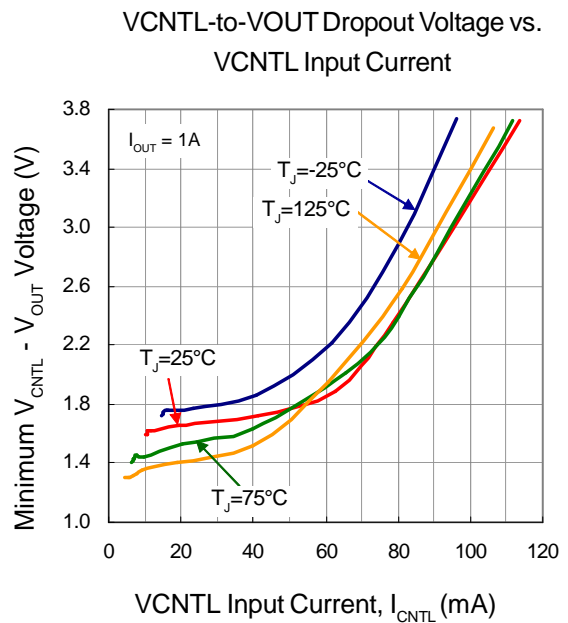
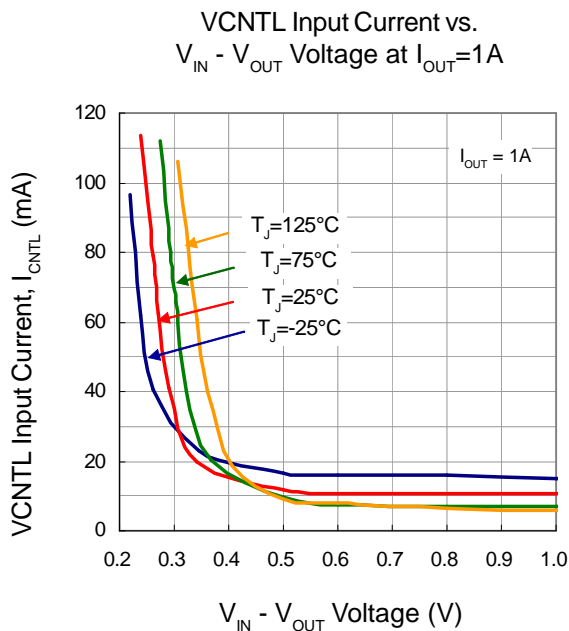
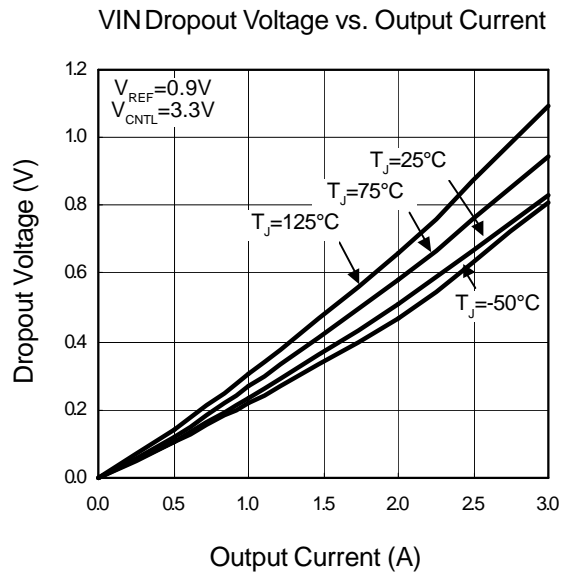
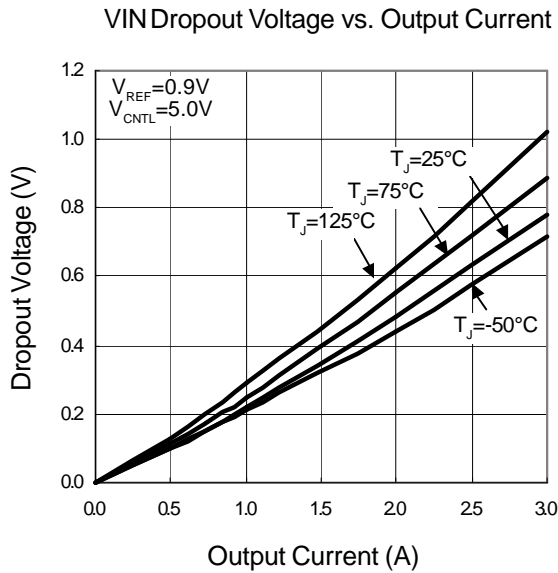

Typical Operating Characteristics (Cont.)

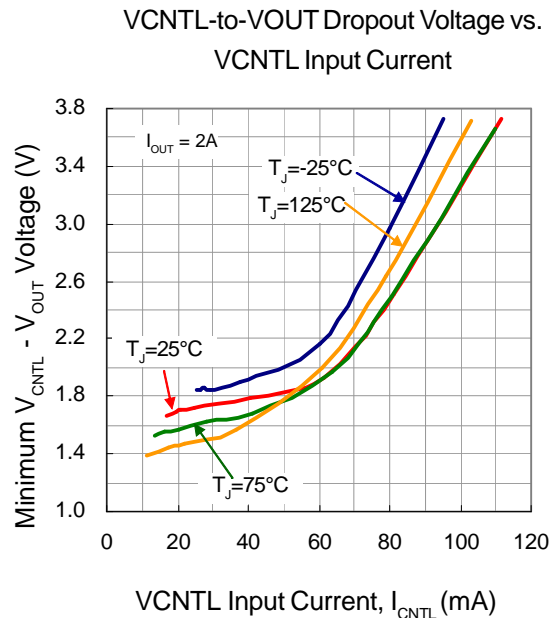
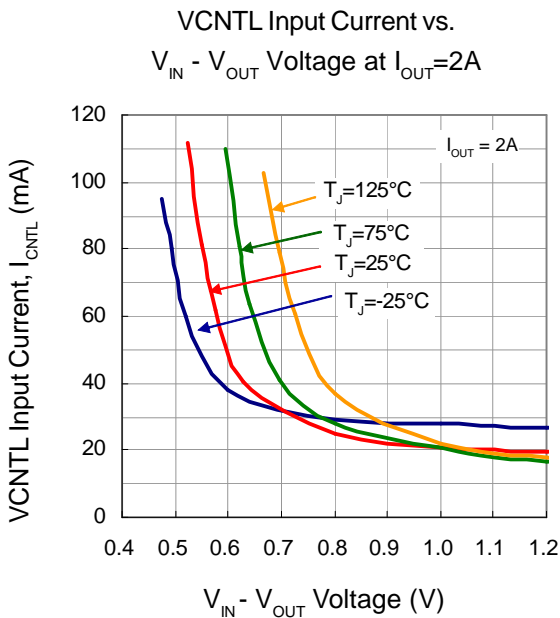
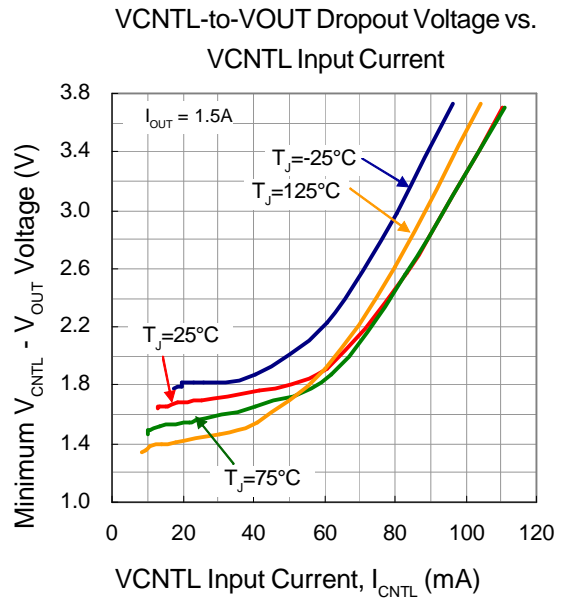
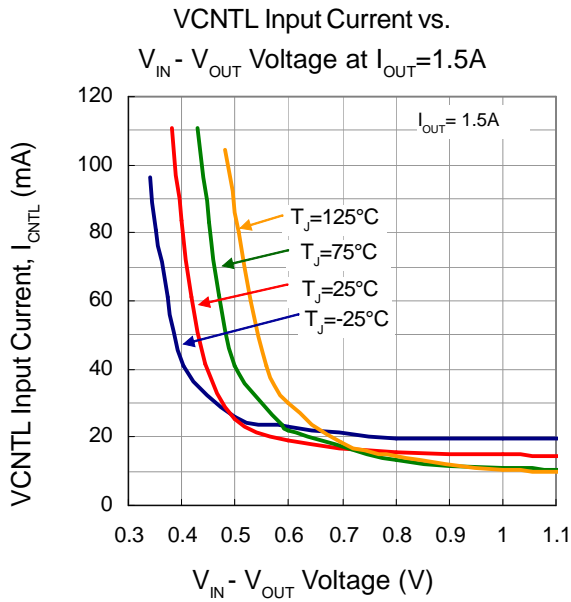



## Operating Waveforms

### 1. Load Transient Response : $I_{OUT} = +10mA \rightarrow +3A \rightarrow +10mA$

- $V_{IN} = 2.5V$ ,  $V_{CNTL} = 3.3V$
- $V_{REF}$  is 1.250V supplied by a regulator
- $C_{OUT} = 470\mu F/10V$ ,  $ESR = 30m\Omega$
- $I_{OUT}$  slew rate =  $\pm 3A/\mu s$

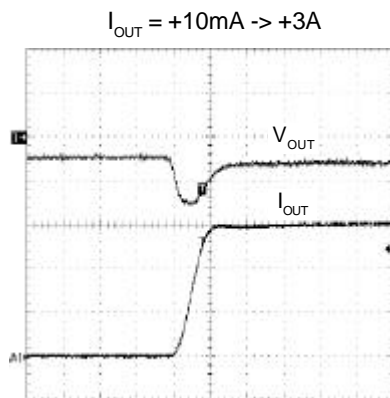

Ch1 :  $V_{OUT}$ , 20mV/Div, DC,  
Offset = 1.250V  
Ax1 :  $I_{OUT}$ , 1A/Div  
Time : 1 $\mu s$ /Div

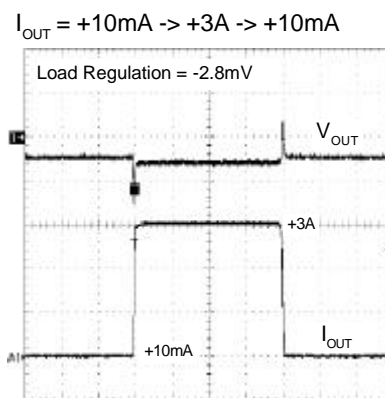

Ch1 :  $V_{OUT}$ , 20mV/Div, DC,  
Offset = 1.250V  
Ax1 :  $I_{OUT}$ , 1A/Div  
Time : 20 $\mu s$ /Div

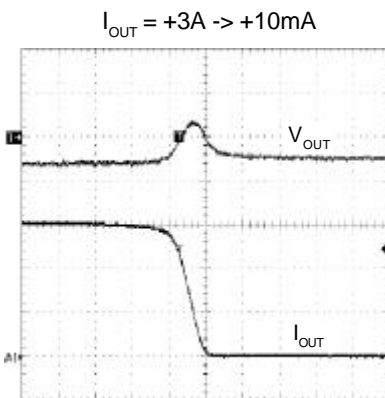

Ch1 :  $V_{OUT}$ , 20mV/Div, DC,  
Offset = 1.250V  
Ax1 :  $I_{OUT}$ , 1A/Div  
Time : 1 $\mu s$ /Div

### 2. Load Transient Response : $I_{OUT} = -10mA \rightarrow -3A \rightarrow -10mA$

- $V_{IN} = 2.5V$ ,  $V_{CNTL} = 3.3V$
- $V_{REF}$  is 1.250V supplied by a regulator
- $C_{OUT} = 470\mu F/10V$ ,  $ESR = 30m\Omega$
- $I_{OUT}$  slew rate =  $\pm 3A/\mu s$

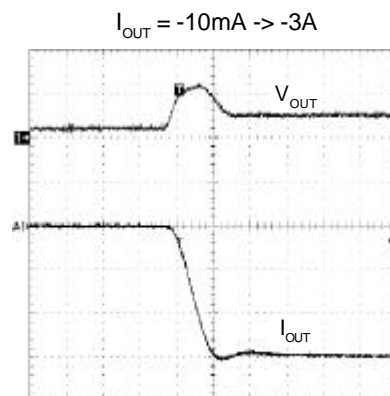

Ch1 :  $V_{OUT}$ , 20mV/Div, DC,  
Offset = 1.250V  
Ax1 :  $I_{OUT}$ , 1A/Div  
Time : 1 $\mu s$ /Div

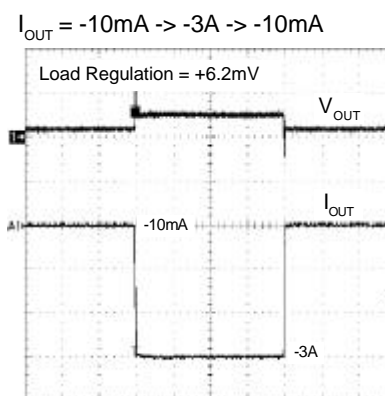

Ch1 :  $V_{OUT}$ , 20mV/Div, DC,  
Offset = 1.250V  
Ax1 :  $I_{OUT}$ , 1A/Div  
Time : 20 $\mu s$ /Div

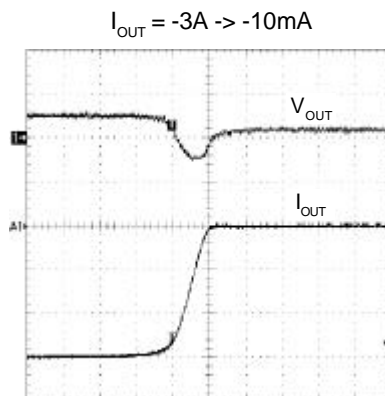

Ch1 :  $V_{OUT}$ , 20mV/Div, DC,  
Offset = 1.250V  
Ax1 :  $I_{OUT}$ , 1A/Div  
Time : 1 $\mu s$ /Div

### Operating Waveforms (Cont.)

#### 3. Load Transient Response : $I_{OUT} = +3A \rightarrow -3A \rightarrow +3A$

- $V_{IN} = 2.5V, V_{CNTL} = 3.3V$
- $V_{REF}$  is 1.250V supplied by a regulator
- $C_{OUT} = 470\mu F/10V, ESR = 30m\Omega$
- $I_{OUT}$  slew rate =  $\pm 3A/\mu s$

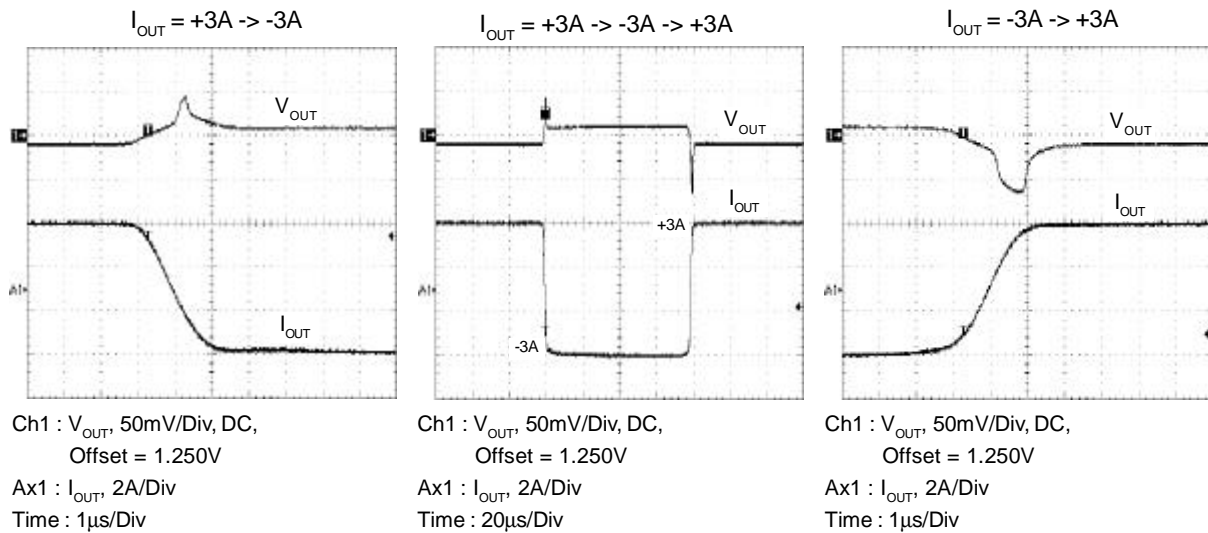

#### 4. Short-Circuit Test

- $V_{IN} = 2.5V, V_{CNTL} = 3.3V$

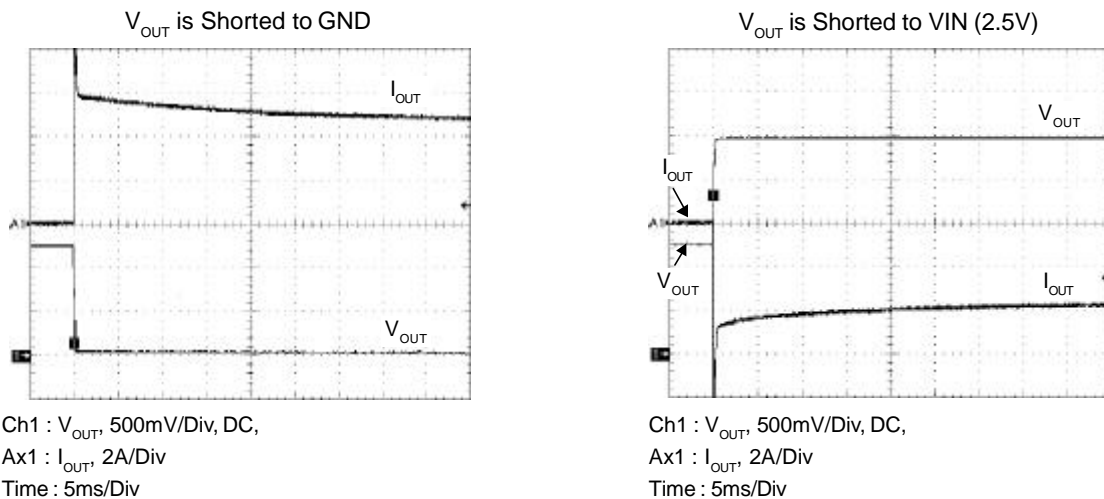

**Block Diagram**

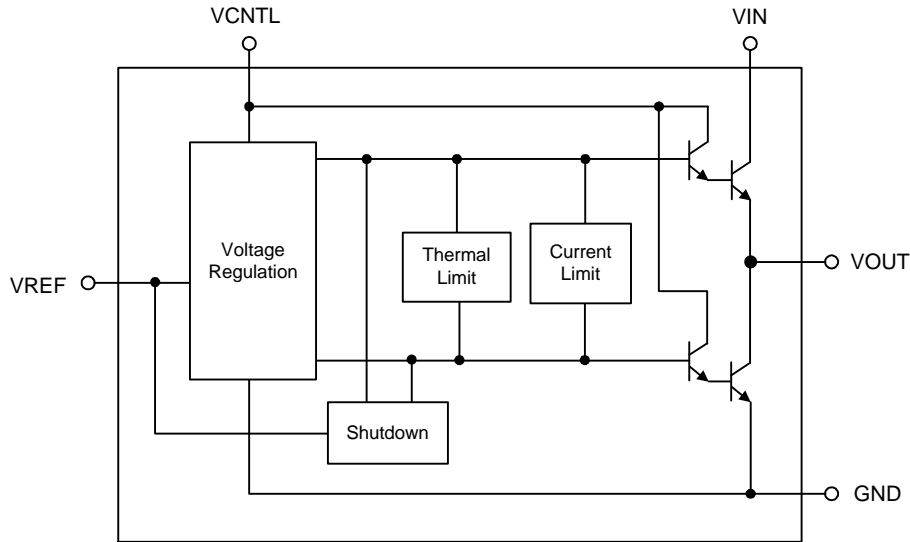

**Pin Description**

PIN NAME	I/O	DESCRIPTION
VIN	I	Main power input pin. Connect this pin to a voltage source and an input capacitor. The APL5331 sources current to VOUT pin by controlling the upper NPN pass transistor, providing a current path from VIN pin.
GND	O	Power and signal ground. Connect this pin to system ground plane with shortest traces. The APL5331 sinks current from VOUT pin by controlling the lower NPN pass transistor, providing a current path to GND pin. This pin is also the ground path for internal control circuitry.
VCNTL	I	Power input pin for internal control circuitry. Connect this pin to a voltage source, providing a bias for the internal control circuitry. A bypass capacitor is usually connected near this pin.
VREF	I	Reference voltage input and active-low shutdown control pin. Apply a voltage to this pin as a reference voltage for the APL5331. Connect this pin to a resistor divider, between VIN and GND, and a capacitor for soft-start and filtering noise purposes. Applying and holding this VREF voltage low by an open-drain transistor to shut down the output.
VOUT	O	Output pin of the regulator. Connect this pin to load. The output capacitors connected to this pin improve stability and transient response. The output voltage tracks the reference voltage and is capable of sourcing or sinking current up to 3A.

## Typical Application Circuit

### 1. $V_{OUT}=1.25V/0.9V$ Application

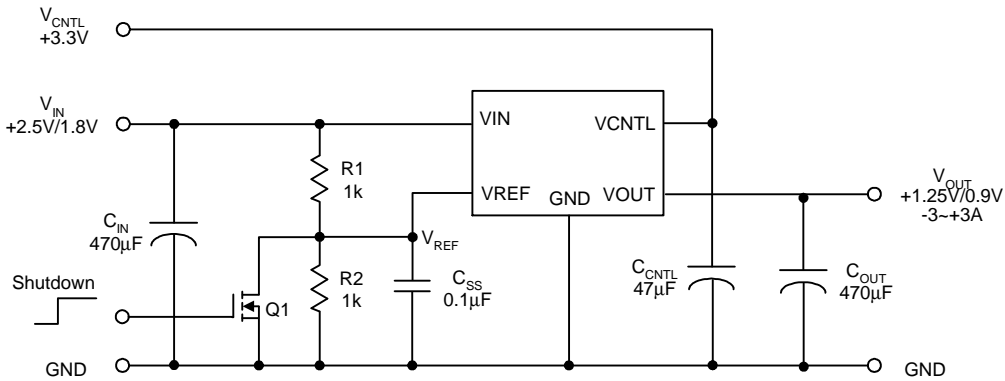

$C_{OUT}$  : 470µF, ESR=25mΩ

R1, R2 : 1kΩ, 1%

Q1 : APM2300 AC

Note : Since R1 and R2 are very small, the voltage offset caused by the bias current of VREF can be ignore.

### 2. $V_{OUT}=1.4V$ Application

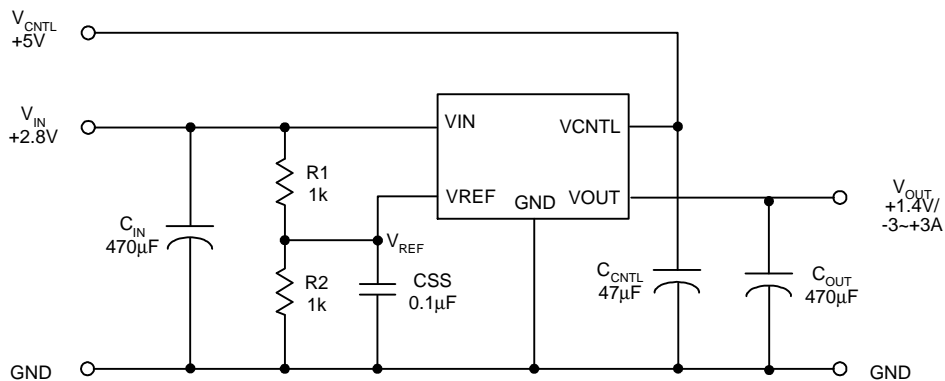

### 3. General Application

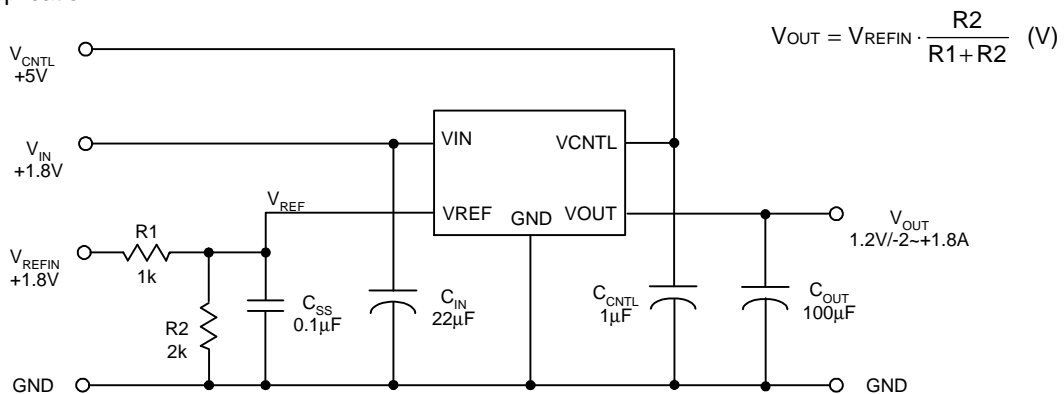

## Application Information

### General

The APL5331 is a linear regulator and is capable of sourcing or sinking current up to 3A. The APL5331 has fast transient response, accurate output voltage (small voltage offset, load regulation), active-low shutdown control and fault protections (current-limit, thermal shutdown). The APL5331 is available in several packages to meet different of power dissipation in requirement various applications.

### Output Voltage Regulation

The output voltage at VOUT pin tracks the reference voltage applied at VREF pin. Two internal NPN pass transistors controlled by separate high bandwidth error amplifiers regulate the output voltage by sourcing current from VIN pin or sinking current to GND pin. The base currents of the pass transistors are provided by VCNTL pin. An internal kelvin sensing scheme senses the output voltage on VOUT pin for perfect load regulation. To prevent two pass transistors from shoot-through, a small voltage offset is created between the positive inputs of the two error amplifiers. This results in higher output voltage while the regulator sinks load current. Since the APL5331 exhibits very fast load transient response, lesser amount of capacitors can be used. In addition, capacitors with high ESR can also be used.

### Current Limit

The APL5331 monitors sourcing and sinking output currents, and limits the maximum output currents to prevent damages during overload or short-circuit condition. To increase the voltage across the internal pass transistors will get higher current-limit points.

### Shutdown and Soft-Start

The VREF pin is a dual-function input pin, acting as reference input and shutdown control input. Applying

### Shutdown and Soft-Start (Cont.)

and holding a voltage below 0.35V (typ.) to VREF pin shuts down the output of the regulator. An NPN transistor or N-channel MOSFET is used to pull down the VREF voltage while applying a “high” signal to turn on the transistor. When shutdown function is active, both pass transistors are turned off and the impedance of the VOUT is about 10m $\Omega$  (typ.), sourcing or sinking no current. When release the VREF pin, the current through the resistor divider charges the soft-start capacitor to initiate a soft-start process which controls the rise rate of the output voltage and limits the input surge current.

### Thermal Shutdown

A thermal shutdown circuit limits the junction temperature of the APL5331. When the junction temperature exceeds +183°C, a thermal sensor turns off both pass transistors, allowing the device to cool down. The regulator starts to regulate again after the junction temperature reduces by 40°C, resulting in a pulsed output during continuous thermal overload conditions. The thermal limit designed with a 40°C hysteresis lowers the average  $T_J$  during continuous thermal overload conditions, and extends lifetime of APL5331.

### Power Inputs

It's not necessary to pay attention to the sequencing of the input voltages on VIN and VCNTL pins. However, do not apply a voltage to VOUT when the VCNTL voltage is not present. This reason is that the internal parasitic diodes connected from VOUT to VIN and from VOUT to VCNTL will be forward biased. When the VIN input voltage is not present, the APL5331 can only source few current up to 100mA to output. In the same condition, the APL5331 keeps same capability of sinking output current up to 3A.

## Application Information (Cont.)

### Reference Voltage

A reference voltage is applied at the VREF pin by a resistor divider between VIN and GND pins. Normally, the bias current flowing out of the VREF pin is about 150nA (typ.), creating voltage offset at the resistor divider and affecting the output voltage accuracy. The recommended resistor is <math><5k\Omega</math> to maintain accuracy of the output voltage. An external bypass capacitor (>0.1 $\mu\text{F}$ ) is also connected to VREF. The capacitor and the resistor divider form a low-pass filter to reduce the inherent reference noise from VIN. Connect the capacitor as close to VREF as possible for optimal effect. Do not place any additional loading on this reference input pin.

### Output Capacitor

The APL5331 requires a proper output capacitor to maintain stability and improve transient response. The output capacitor selection is dependent upon the ESR (equivalent series resistance) and capacitance of the output capacitor over full temperature range. The following chart shows the stable region of the output capacitor for APL5331. The stable region is above the curve, indicating minimum required ESR and capacitance to maintain stability. However, the output capacitor should have an ESR less than 1 $\Omega$ .

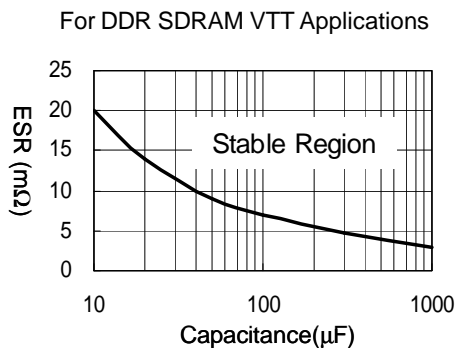

### Output Capacitor (Cont.)

Ultra-low-ESR capacitors, such as ceramic chip capacitors, may promote under-damped transient

response, but proper ceramic chip capacitors placed near loads can be used as decoupling capacitors. A low-ESR solid tantalum and aluminum electrolytic capacitor ( $\text{ESR} < 1\Omega$ ) works extremely well and provides good transient response and stability over temperature.

The output capacitors are also used to reduce the slew rate of load current and help the APL5331 to minimize variations of the output voltage, improving transient response. For this purpose, the low-ESR capacitors depending on the step size and slew rate of a load current step are recommended.

### Input Capacitor

The input capacitors for VCNTL and VIN pins are not required for stability but for supplying surge currents during large load transients. The input capacitors prevent the input rail from dipping to improve the performance of the APL5331. Reducing the parasitic inductance and resistance of current paths from power sources to the APL5331 also reduces voltage dips on VCNTL and VIN pins.

A capacitor of 1 $\mu\text{F}$  (ceramic chip capacitor) or greater (aluminum electrolytic capacitor) is recommended for VCNTL pin. For VIN pin, an aluminum electrolytic capacitor (>50 $\mu\text{F}$ ) is recommended. It is not necessary to use low-ESR capacitors.

### Layout and Thermal Consideration

The input capacitors for VIN and VCNTL pins are normally placed near each pin for good performances. Ceramic decoupling capacitors for loads must be placed as close to the loads to reduce the parasitic inductors of traces. It is also recommended that the APL5331 and output capacitors are placed near the load for good load

## Application Information (Cont.)

### Layout and Thermal Consideration (Cont.)

regulation and load transient response. The negative pins of the input and output capacitors and the GND pin of the APL5331 should connect to analog ground plane of the load.

See figure 1. The SOP-8P utilizes a bottom thermal pad to minimize the thermal resistance of the package, making the package suitable for high current applications. The thermal pad is soldered to the top ground pad and is connected to the internal or bottom ground plane by several vias. The printed circuit board (PCB) forms a heat sink and dissipates most of the heat into the ambient air. The vias are recommended to have proper size to retain solder, helping heat conduction.

Thermal resistance consists of two main elements,  $\theta_{JC}$  (junction-to-case thermal resistance) and  $\theta_{CA}$  (case-to-ambient thermal resistance).  $\theta_{JC}$  is specified from the IC junction to the bottom of the thermal pad directly below the die.  $\theta_{CA}$  is the resistance from the bottom of thermal pad to the ambient air and it includes  $\theta_{CS}$  (case-to-sink thermal resistance) and  $\theta_{SA}$  (sink-to-ambient thermal resistance). The specified path for heat flow is the lowest resistance path and it dissipates majority of the heat to the ambient air. Typically,  $\theta_{CA}$  is the dominant thermal resistance. Therefore, enlarging the internal or bottom ground plane reduces the resistance  $\theta_{CA}$ . The relationship between power dissipation and temperatures is the following equation:

$$P_D = (T_J - T_A) / \leq \theta_{JA}$$

where,

$P_D$  : Power dissipation

$T_J$  : Junction Temperature

$T_A$  : Ambient Temperature

$\theta_{JA}$ : Junction-to-Ambient Thermal Resistance

Figure 2 shows a board layout using the SOP-8P package. The demo board is made of FR-4 material

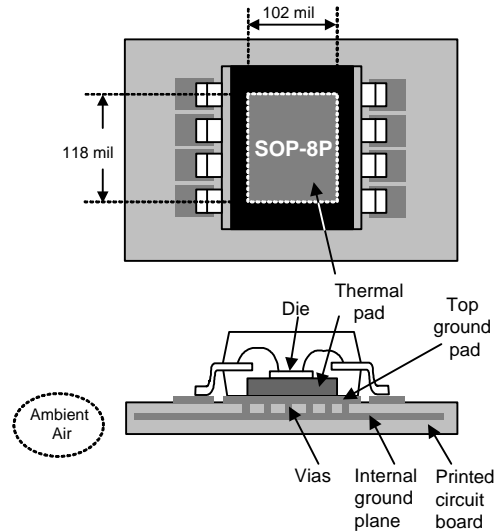

Figure 1 Package Top and side view

and is a two-layer PCB. The size and thickness are 65mm\* 65mm and 1.6mm. An area of 140mil\*105mil on the top layer is use as a thermal pad for the APL5331 and this is connected to the bottom layer by vias. The bottom layer using 2 oz. copper acts as the ground plane for the system. The PCB and all components on the board form a heat sink. The  $\theta_{JA}$  of the APL5331 (SOP-8P) mounted on this demo board is about 37°C/W in free air. Assuming the  $T_A=25^\circ\text{C}$  and the maximum  $T_J=150^\circ\text{C}$  (typical thermal limit temperature), the maximum power dissipation is calculated as :

$$P_D (\text{max}) = (150 - 25) / 37 \\ = 3.38\text{W}$$

If the  $T_J$  is designed to be below 125°C, the calculated power dissipation should be less than :

$$P_D = (125 - 25) / 37 \\ = 2.70\text{W}$$



Application Information (Cont.)

Layout and Thermal Consideration (Cont.)

Recommended Minimum Footprint

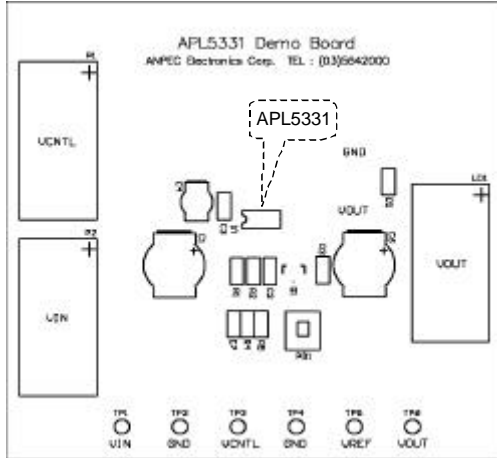
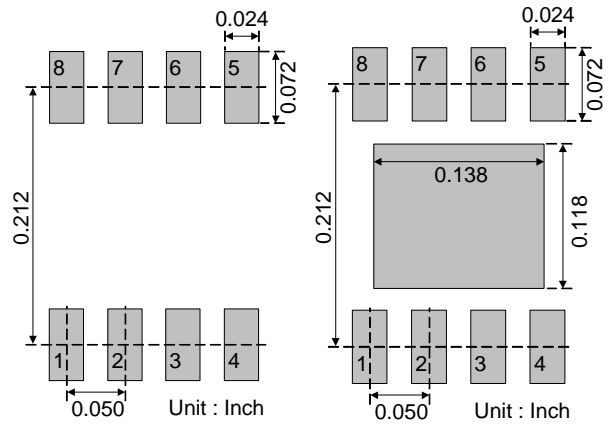

Figure 2(a) TopOver layer



SOP-8

SOP-8P

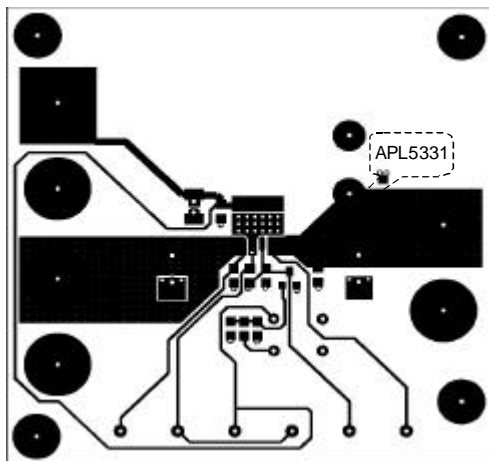
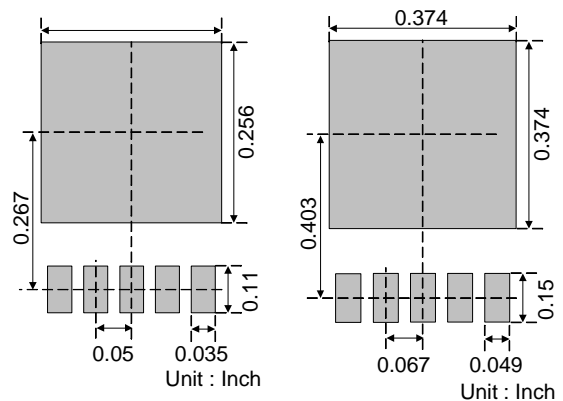

Figure 2(b) Top layer



TO-252-5

TO-263-5

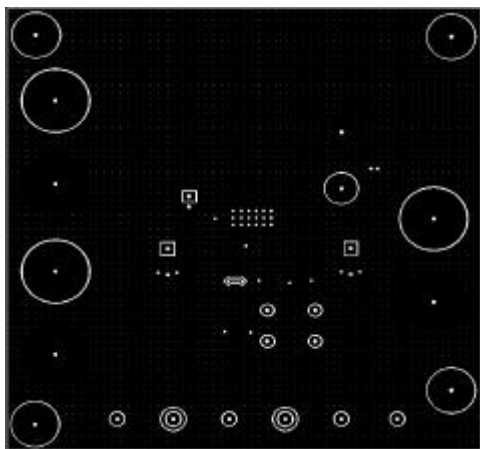
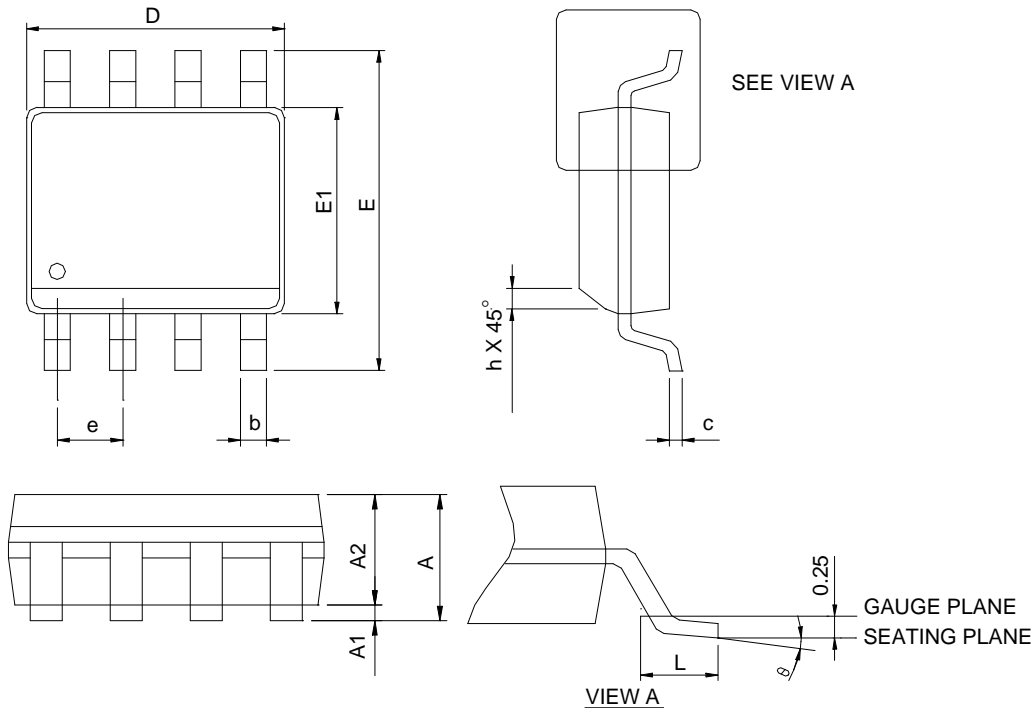

Figure 2(c) Bottom layer



## Package Information

SOP-8



SYMBOL	SOP-8			
	MILLIMETERS		INCHES	
	MIN.	MAX.	MIN.	MAX.
A		1.75		0.069
A1	0.10	0.25	0.004	0.010
A2	1.25		0.049	
b	0.31	0.51	0.012	0.020
c	0.17	0.25	0.007	0.010
D	4.80	5.00	0.189	0.197
E	5.80	6.20	0.228	0.244
E1	3.80	4.00	0.150	0.157
e	1.27 BSC		0.050 BSC	
h	0.25	0.50	0.010	0.020
L	0.40	1.27	0.016	0.050
$\theta$	0°	8°	0°	8°

- Note: 1. Follow JEDEC MS-012 AA.  
 2. Dimension "D" does not include mold flash, protrusions or gate burrs. Mold flash, protrusion or gate burrs shall not exceed 6 mil per side.  
 3. Dimension "E" does not include inter-lead flash or protrusions. Inter-lead flash and protrusions shall not exceed 10 mil per side.

### Package Information

SOP-8P

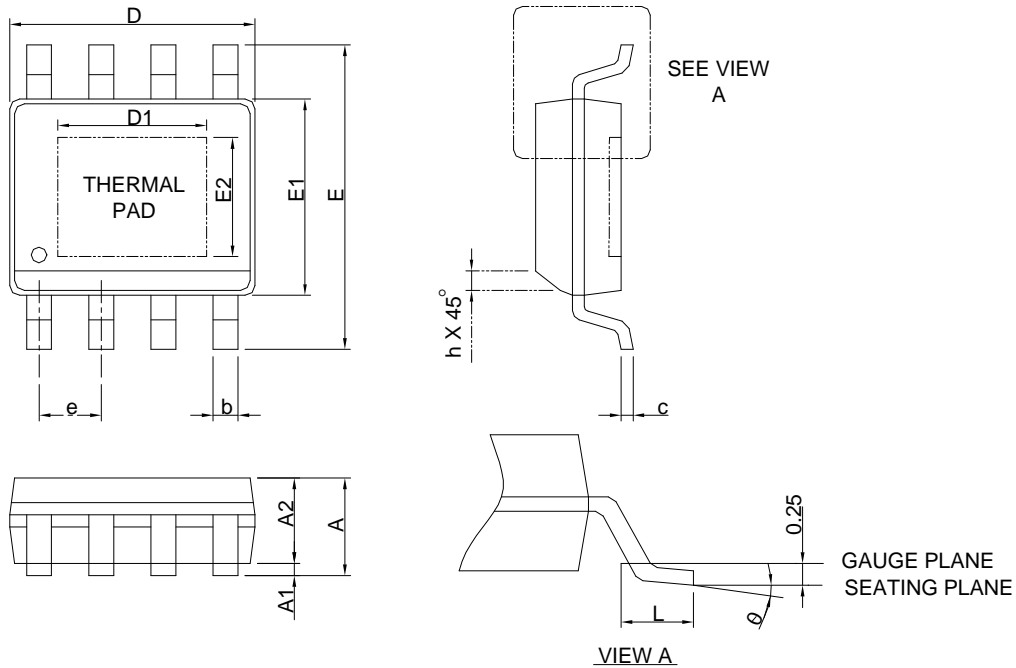

SYMBOL	SOP-8P			
	MILLIMETERS		INCHES	
	MIN.	MAX.	MIN.	MAX.
A		1.75		0.069
A1	0.00	0.15	0.000	0.006
A2	1.25		0.049	
b	0.31	0.51	0.012	0.020
c	0.17	0.25	0.007	0.010
D	4.80	5.00	0.189	0.197
D1	2.25	3.50	0.098	0.138
E	5.80	6.20	0.228	0.244
E1	3.80	4.00	0.150	0.157
E2	2.00	3.00	0.079	0.118
e	1.27 BSC		0.050 BSC	
h	0.25	0.50	0.010	0.020
L	0.40	1.27	0.016	0.050
θ	0°	8°	0°	8°

- Note : 1. Follow JEDEC MS-012 BA.  
 2. Dimension "D" does not include mold flash, protrusions or gate burrs. Mold flash, protrusion or gate burrs shall not exceed 6 mil per side .  
 3. Dimension "E" does not include inter-lead flash or protrusions. Inter-lead flash and protrusions shall not exceed 10 mil per side.

Package Information

TO-252-5

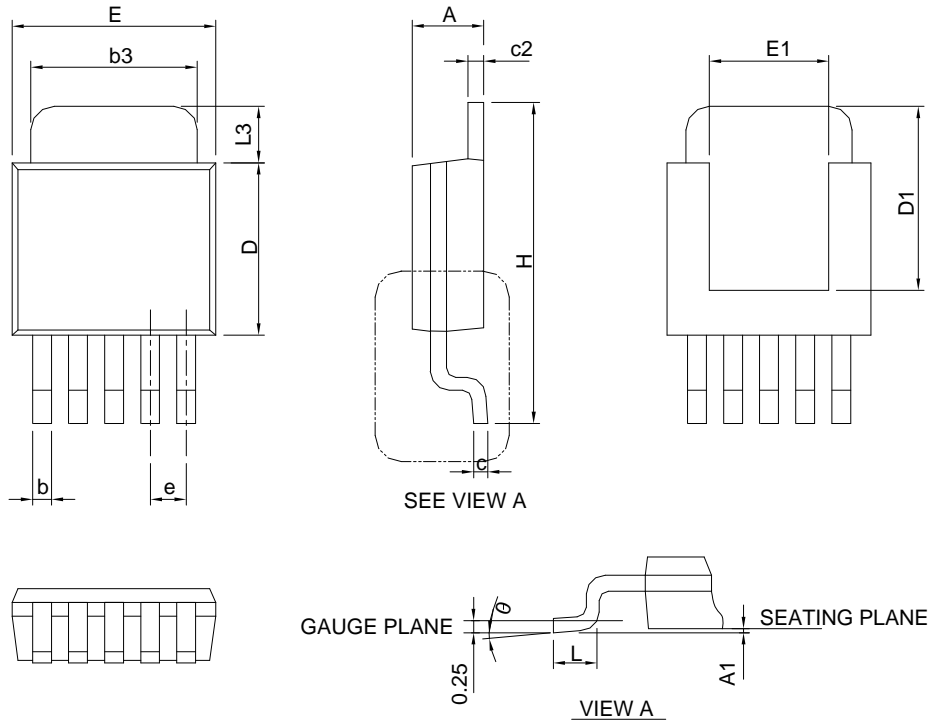

DIMENSIONS	TO-252-5			
	MILLIMETERS		INCHES	
	MIN.	MAX.	MIN.	MAX.
A	2.18	2.39	0.086	0.094
A1		0.13		0.005
b	0.50	0.89	0.020	0.035
b3	4.32	5.46	0.170	0.215
c	0.46	0.61	0.018	0.024
c2	0.46	0.89	0.018	0.035
D	5.33	6.22	0.210	0.245
D1	4.57	6.00	0.180	0.236
E	6.35	6.73	0.250	0.265
E1	3.81	6.00	0.150	0.236
e	1.27 BSC		0.050 BSC	
H	9.40	10.41	0.370	0.410
L	1.40	1.78	0.055	0.070
L3	0.89	2.03	0.035	0.080
$\theta$	0°	8°	0°	8°

Package Information

TO-263-5

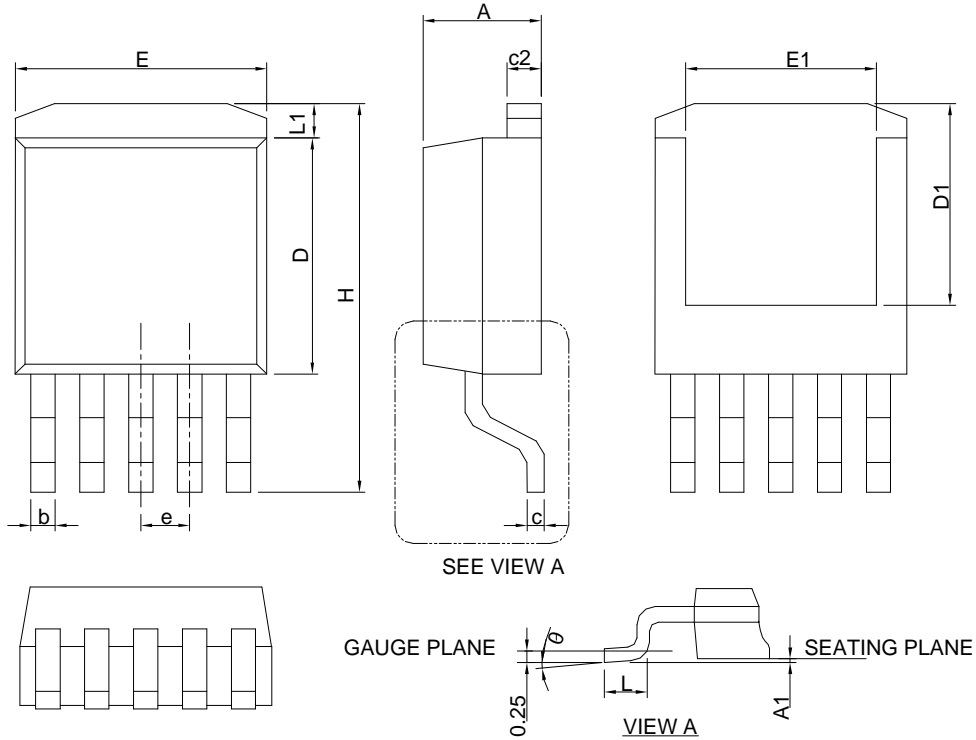

SYMBOL	TO-263-5			
	MILLIMETERS		INCHES	
	MIN.	MAX.	MIN.	MAX.
A	4.06	4.83	0.160	0.190
A1	0.00	0.25	0.000	0.010
b	0.51	0.99	0.020	0.039
c	0.38	0.74	0.015	0.029
c2	1.14	1.65	0.045	0.065
D	8.38	9.65	0.330	0.380
D1	6.00	9.00	0.236	0.354
E	9.65	11.43	0.380	0.450
E1	6.22	9.00	0.245	0.354
e	1.70 BSC		0.067 BSC	
H	14.61	15.88	0.575	0.625
L	1.78	2.79	0.070	0.110
L1		1.68		0.066
θ	0°	8°	0°	8°

Note : Follow from JEDEC TO-263 BB.

### Carrier Tape & Reel Dimensions

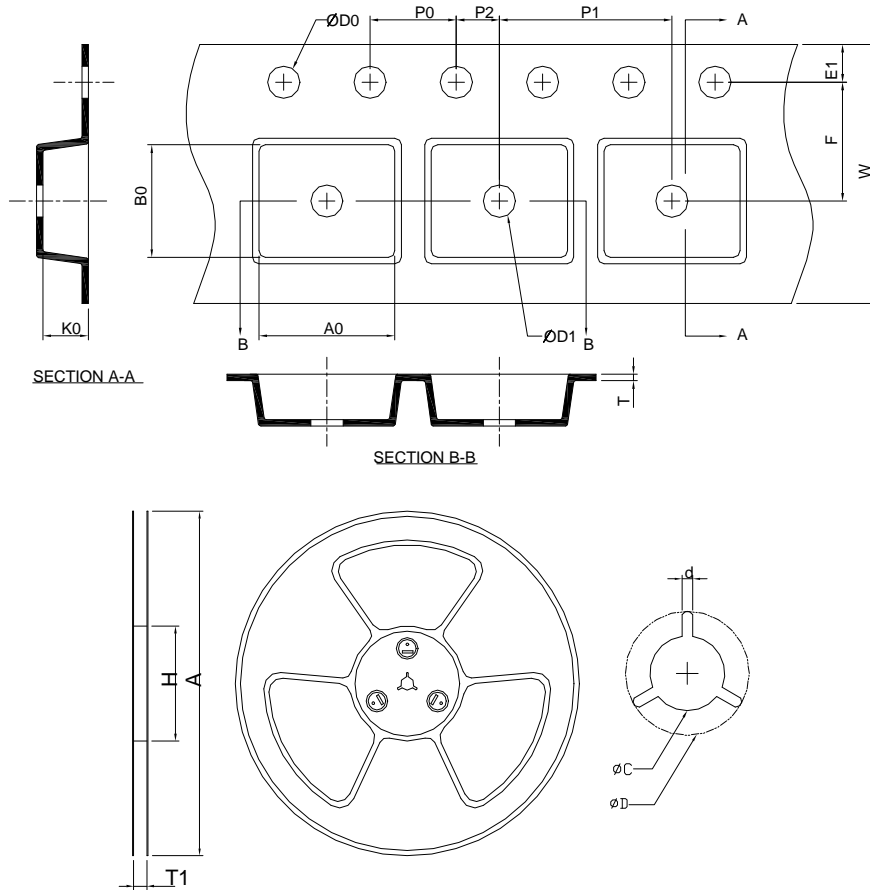

Application	A	H	T1	C	d	D	W	E1	F
SOP-8(P)	330.0 ±2.00	50 MIN.	12.4+2.00 -0.00	13.0+0.50 -0.20	1.5 MIN.	20.2 MIN.	12.0 ±0.30	1.75 ±0.10	5.5 ±0.05
	P0	P1	P2	D0	D1	T	A0	B0	K0
	4.0 ±0.10	8.0 ±0.10	2.0 ±0.05	1.5+0.10 -0.00	1.5 MIN.	0.6+0.00 -0.40	6.40 ±0.20	5.20 ±0.20	2.10 ±0.20
Application	A	H	T1	C	d	D	W	E1	F
TO-252-5	330.0 ±2.00	50 MIN.	16.4+2.00 -0.00	13.0+0.50 -0.20	1.5 MIN.	20.2 MIN.	16.0 ±0.30	1.75 ±0.10	7.50 ±0.05
	P0	P1	P2	D0	D1	T	A0	B0	K0
	4.0 ±0.10	8.0 ±0.10	2.0 ±0.05	1.5+0.10 -0.00	1.5 MIN.	0.6+0.00 -0.40	6.80 ±0.20	10.40 ±0.20	2.50 ±0.20
Application	A	H	T1	C	d	D	W	E1	F
TO-263-5	381.0 ±2.00	60 MIN.	24.4+2.00 -0.00	13.0+0.50 -0.20	1.5 MIN.	20.2 MIN.	24.0 ±0.30	1.75 ±0.10	11.5 ±0.10
	P0	P1	P2	D0	D1	T	A0	B0	K0
	4.0 ±0.10	16.0 ±0.10	2.0 ±0.10	1.5+0.10 -0.00	1.5 MIN.	0.6+0.00 -0.40	10.8 ±0.20	16.1 ±0.20	5.2 ±0.20

(mm)

**Devices Per Unit**

Package Type	Unit	Quantity
SOP-8(P)	Tape & Reel	2500
TO-252-5	Tape & Reel	2500
TO-263-5	Tape & Reel	1000

**Reflow Condition (IR/Convection or VPR Reflow)**

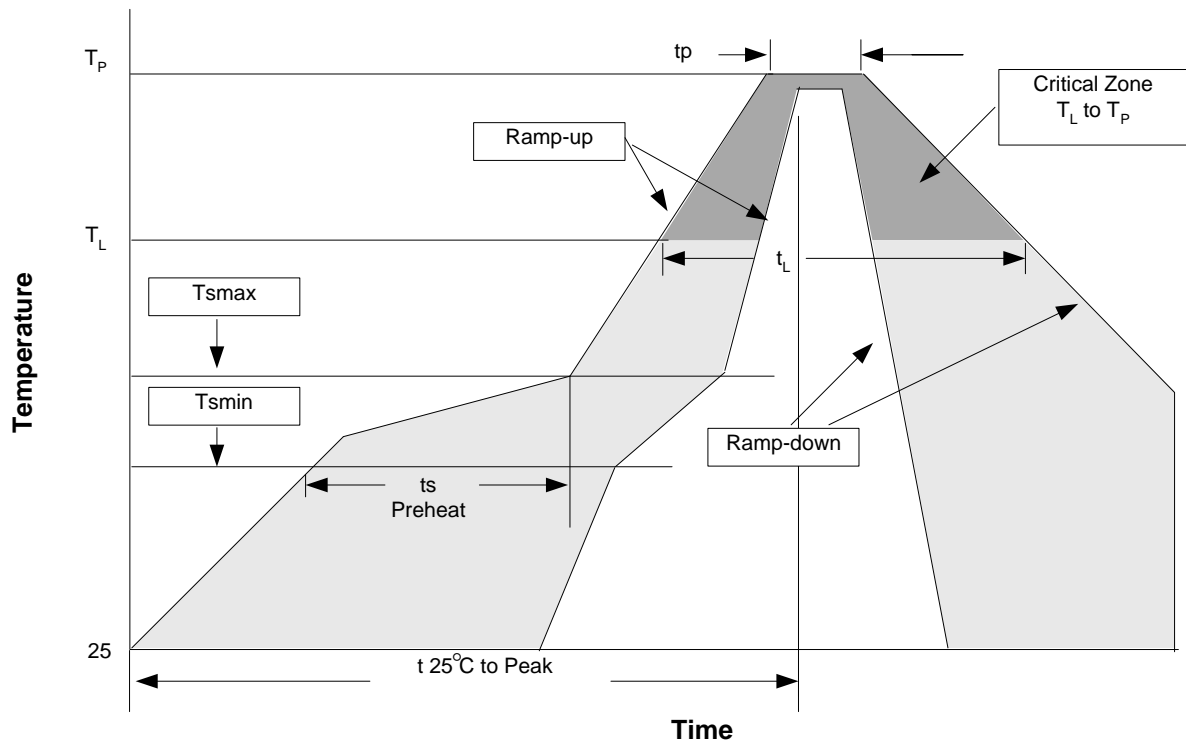

**Reliability Test Program**

Test item	Method	Description
SOLDERABILITY	MIL-STD-883D-2003	245°C, 5 sec
HOLT	MIL-STD-883D-1005.7	1000 Hrs Bias @125°C
PCT	JESD-22-B,A102	168 Hrs, 100%RH, 121°C
TST	MIL-STD-883D-1011.9	-65°C~150°C, 200 Cycles
ESD	MIL-STD-883D-3015.7	VHBM > 2KV, VMM > 200V
Latch-Up	JESD 78	10ms, 1 <sub>tr</sub> > 100mA

## Classification Reflow Profiles

Profile Feature	Sn-Pb Eutectic Assembly	Pb-Free Assembly
Average ramp-up rate (T <sub>L</sub> to T <sub>P</sub> )	3°C/second max.	3°C/second max.
Preheat - Temperature Min (T <sub>smin</sub> ) - Temperature Max (T <sub>smax</sub> ) - Time (min to max) (t <sub>s</sub> )	100°C 150°C 60-120 seconds	150°C 200°C 60-180 seconds
Time maintained above: - Temperature (T <sub>L</sub> ) - Time (t <sub>L</sub> )	183°C 60-150 seconds	217°C 60-150 seconds
Peak/Classification Temperature (T <sub>p</sub> )	See table 1	See table 2
Time within 5°C of actual Peak Temperature (t <sub>p</sub> )	10-30 seconds	20-40 seconds
Ramp-down Rate	6°C/second max.	6°C/second max.
Time 25°C to Peak Temperature	6 minutes max.	8 minutes max.

Note: All temperatures refer to topside of the package. Measured on the body surface.

Table 1. SnPb Eutectic Process – Package Peak Reflow Temperatures

Package Thickness	Volume mm <sup>3</sup> <350	Volume mm <sup>3</sup> ≥350
<2.5 mm	240 +0/-5°C	225 +0/-5°C
≥2.5 mm	225 +0/-5°C	225 +0/-5°C

Table 2. Pb-free Process – Package Classification Reflow Temperatures

Package Thickness	Volume mm <sup>3</sup> <350	Volume mm <sup>3</sup> 350-2000	Volume mm <sup>3</sup> >2000
<1.6 mm	260 +0°C*	260 +0°C*	260 +0°C*
1.6 mm – 2.5 mm	260 +0°C*	250 +0°C*	245 +0°C*
≥2.5 mm	250 +0°C*	245 +0°C*	245 +0°C*

\* Tolerance: The device manufacturer/supplier **shall** assure process compatibility up to and including the stated classification temperature (this means Peak reflow temperature +0°C. For example 260°C+0°C) at the rated MSL level.

## Customer Service

### Anpec Electronics Corp.

Head Office :

No.6, Dusing 1st Road, SBIP,  
Hsin-Chu, Taiwan, R.O.C.  
Tel : 886-3-5642000  
Fax : 886-3-5642050

Taipei Branch :

2F, No. 11, Lane 218, Sec 2 Jhongsing Rd.,  
Sindian City, Taipei County 23146, Taiwan  
Tel : 886-2-2910-3838  
Fax : 886-2-2917-3838