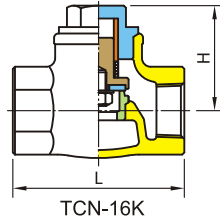
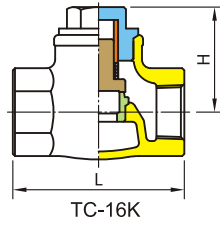

JIS-10K**球狀石墨鑄鐵立式逆止閥
Ductile Iron Lift Check Valve****螺紋口
Screwed****TC-16K (SUS Disc)
TCN-16K (Viton Disc)**

標稱壓力 Working pressure marking16 kgf/cm²
 120°C 以下之靜流水
 Non shock water under 120°C14 kgf/cm²
 220°C 以下之蒸汽、氣體、瓦斯、油、脈動水
 Steam, Air, Gas, Oil, Pulse stream under 220°C10 kgf/cm²
 ※Viton墊片最高使用溫度200°C (392°F)

測試壓力 Test Pressure

閥體 Body	24 kgf/cm ² (Hydrostatic)
閥座 Seat	15 kgf/cm ² (Hydrostatic)
	6 kgf/cm ² (Air)

· Connection.....Screwed End (P.T)

Size	mm	10	15	20	25	32	40	50
	inch	3/8	1/2	3/4	1	1 1/4	1 1/2	2
L		60	65	80	90	105	120	140
H		47	47	54	55	67	76	83

Parts and materials list

閥體 Body	FCD450
閥蓋 Cap	FCD450
閥門 Disc	SUS410/Viton
閥座 Seat Ring	SUS410
彈簧 Spring	SUS304

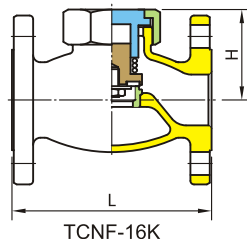
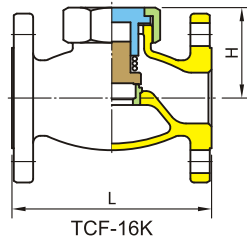
JIS-10K**球狀石墨鑄鐵立式逆止閥
Ductile Iron Lift Check Valve****法蘭口
Flanged****TCF-16K (SUS Disc)
TCNF-16K (Viton Disc)**

標稱壓力 Working pressure marking16 kgf/cm²
 120°C 以下之靜流水
 Non shock water under 120°C14 kgf/cm²
 220°C 以下之蒸汽、氣體、瓦斯、油、脈動水
 Steam, Air, Gas, Oil, Pulse stream under 220°C10 kgf/cm²
 ※Viton墊片最高使用溫度200°C (392°F)

測試壓力 Test Pressure

閥體 Body	24 kgf/cm ² (Hydrostatic)
閥座 Seat	15 kgf/cm ² (Hydrostatic)
	6 kgf/cm ² (Air)

Parts and materials list

閥體 Body	FCD450
閥蓋 Bonnet	SUS410
閥蓋襯套 Bonnet Ring	SUS410
連接螺帽 Lock Nut	FCD450
墊片 Gasket	Non Asbestos
閥門 Disc	SUS410/Viton
閥座 Seat Ring	SUS410
彈簧 Spring	SUS304

· Connection.....Flanged End (R.F)

Size	mm	15	20	25	32	40	50
	inch	1/2	3/4	1	1 1/4	1 1/2	2
L		108	117	127	140	165	203
H		55	60	66	68	82	84

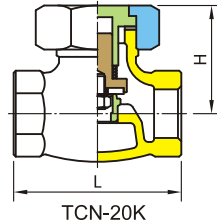
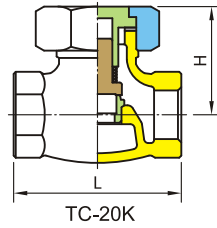
JIS-20K**球狀石墨鑄鐵立式逆止閥
Ductile Iron Lift Check Valve****螺紋口
Screwed****TC-20K (SUS Disc)
TCN-20K (Viton Disc)**

標稱壓力 Working pressure marking20 kgf/cm²
 120°C以下之靜流水
 Non shock water under 120°C28 kgf/cm²
 220°C以下之蒸汽、氣體、瓦斯、油、脈動水
 Steam, Air, Gas, Oil, Pulse stream under 220°C25 kgf/cm²
 300°C以下之蒸汽、氣體、瓦斯、油、脈動水
 Steam, Air, Gas, Oil, Pulse stream under 300°C23 kgf/cm²
 350°C以下之蒸汽、氣體、瓦斯、油、脈動水
 Steam, Air, Gas, Oil, Pulse stream under 350°C20 kgf/cm²
 ※Viton墊片最高使用溫度200°C (392°F)

測試壓力 Test Pressure

閥體 Body	44 kgf/cm ² (Hydrostatic)
閥座 Seat	32 kgf/cm ² (Hydrostatic)
	6 kgf/cm ² (Air)

Parts and materials list

閥體 Body	FCD450
閥蓋 Bonnet	SUS410
閥蓋襯套 Bonnet Ring	SUS410
連結螺帽 Lock Nut	FCD450
閥門 Disc	SUS410/Viton
閥座 Seat Ring	SUS410
墊片 Gasket	Non Asbestos
彈簧 Spring	SUS304

· Connection.....Screwed End (P.T)

Size	mm	15	20	25	32	40	50
	inch	½	¾	1	1¼	1½	2
L		75	90	105	120	135	160
H		52	56	60	68	76	86

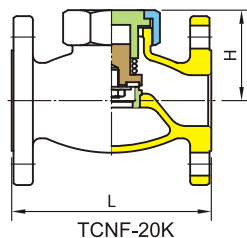
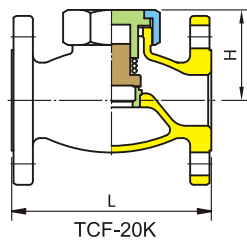
JIS-20K**球狀石墨鑄鐵立式逆止閥
Ductile Iron Lift Check Valve****法蘭口
Flanged****TCF-20K (SUS Disc)
TCNF-20K (Viton Disc)**

標稱壓力 Working pressure marking20 kgf/cm²
 120°C以下之靜流水
 Non shock water under 120°C28 kgf/cm²
 220°C以下之蒸汽、氣體、瓦斯、油、脈動水
 Steam, Air, Gas, Oil, Pulse stream under 220°C25 kgf/cm²
 300°C以下之蒸汽、氣體、瓦斯、油、脈動水
 Steam, Air, Gas, Oil, Pulse stream under 300°C23 kgf/cm²
 350°C以下之蒸汽、氣體、瓦斯、油、脈動水
 Steam, Air, Gas, Oil, Pulse stream under 350°C20 kgf/cm²
 ※Viton墊片最高使用溫度200°C (392°F)

測試壓力 Test Pressure

閥體 Body	44 kgf/cm ² (Hydrostatic)
閥座 Seat	32 kgf/cm ² (Hydrostatic)
	6 kgf/cm ² (Air)

Parts and materials list

閥體 Body	FCD450
閥蓋 Bonnet	SUS410
閥蓋襯套 Bonnet Ring	SUS410
連結螺帽 Lock Nut	FCD450
閥門 Disc	SUS410/Viton
閥座 Seat Ring	SUS410
墊片 Gasket	Non Asbestos
彈簧 Spring	SUS304

· Connection.....Flanged End (R.F)

Size	mm	15	20	25	32	40	50
	inch	½	¾	1	1¼	1½	2
L		110	120	130	160	180	230
H		55	60	63	68	80	86

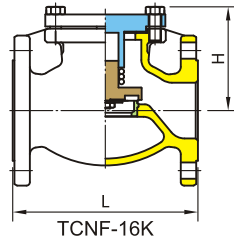
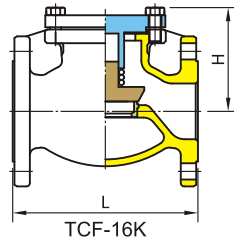
JIS-10K**球狀石墨鑄鐵立式逆止閥
Ductile Iron Lift Check Valve****法蘭口
Flanged****TCF-16K (SUS Disc)
TCNF-16K (Viton Disc)**

標稱壓力 Working pressure marking 16 kgf/cm²
 120°C 以下之靜流水
 Non shock water under 120°C 16 kgf/cm²
 220°C 以下之蒸汽、氣體、瓦斯、油、脈動水
 Steam, Air, Gas, Oil, Pulse stream under 220°C 12 kgf/cm²
 300°C 以下之蒸汽、氣體、瓦斯、油、脈動水
 Steam, Air, Gas, Oil, Pulse stream under 300°C 10 kgf/cm²
 ※Viton 墊片最高使用溫度 200°C (392°F)

測試壓力 Test Pressure

閥體 Body	24 kgf/cm ² (Hydrostatic)
閥座 Seat	15 kgf/cm ² (Hydrostatic)
	6 kgf/cm ² (Air)

Parts and materials list

閥體 Body	FCD450
閥蓋 Bonnet	FCD450
閥蓋襯套 Bonnet Ring	SUS410
閥門 Disc	SUS410/Viton
閥座 Seat Ring	SUS410
墊片 Gasket	Non Asbestos
彈簧 Spring	SUS304

· Connection Flanged End (R.F)

Size	mm	65	80	100	125	150
	inch	2½	3	4	5	6
L		216	241	292	356	406
H		125	135	160	260	280

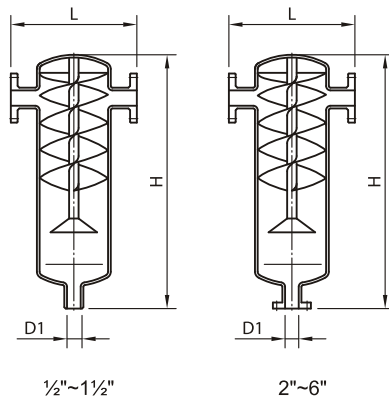
JIS-10K**氣水分離器
Separator****法蘭口
Flanged****TSF-10K**

標稱壓力 Working pressure marking 10 kgf/cm²

測試壓力 Test Pressure

閥體 Body	24 kgf/cm ² (Hydrostatic)
閥座 Seat	15 kgf/cm ² (Hydrostatic)
	6 kgf/cm ² (Air)

Parts and materials list

閥體 Body	Steel
閥蓋 Bonnet	SUS304

· Connection Flanged End (F.F)

Size	mm	15	20	25	32	40	50	65	80	100	125	150
	inch	½	¾	1	1¼	1½	2	2½	3	4	5	6
L		210	210	210	245	245	310	310	370	370	430	430
H		370	370	370	450	450	610	610	760	760	970	970
D1		½"	½"	½"	½"	½"	¾"	¾"	¾"	¾"	1"	1"