

JIS-10K**球狀石墨鑄鐵球型閥**
Ductile Iron Globe Valve**螺紋口**
Screwed**TG-16K (SUS Disc)**
TT-16K (Teflon Disc)

TG-16K

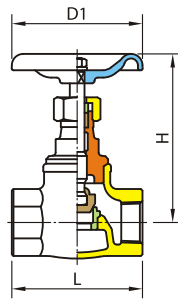
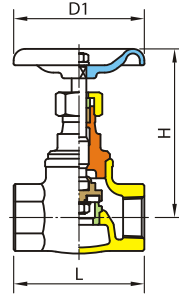

TT-16K

標稱壓力 Working pressure marking16 kgf/cm²

120°C 以下之靜流水

Non shock water under 120°C14 kgf/cm²

220°C 以下之蒸汽、氣體、瓦斯、油、脈動水

Steam, Air, Gas, Oil, Pulse stream under 220°C10 kgf/cm²

※Teflon墊片最高使用溫度 180°C (356°F)

測試壓力 Test Pressure

閥體 Body	24 kgf/cm ² (Hydrostatic)
閥座 Seat	15 kgf/cm ² (Hydrostatic)
	6 kgf/cm ² (Air)

Parts and materials list

閥體 Body	FCD450
閥蓋 Bonnet	FCD450
閥桿 Stem	SUS410
閥門 Disc	SUS410/PTFE+15%G.F.T.
閥座 Seat Ring	SUS410
迫緊 Packing	Graphite
迫緊螺帽 Packing Nut	FCD450
把手 Handwheel	FCD450
銘牌 Name Plate	Aluminum

• Connection.....Screwed End (P.T)

Size	mm	10	15	20	25	32	40	50
	inch	3/8	1/2	3/4	1	1 1/4	1 1/2	2
L		60	65	80	90	105	120	140
H(open)		98	98	112	130	150	165	190
D1		70	70	80	90	100	120	140

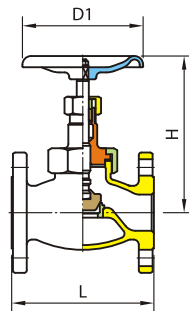
JIS-10K**球狀石墨鑄鐵球型閥**
Ductile Iron Globe Valve**法蘭口**
Flanged**TGF-16K (SUS Disc)**
TTF-16K (Teflon Disc)

TGF-16K

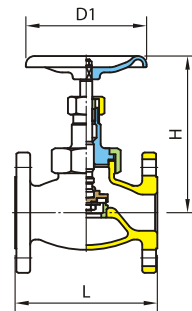

TTF-16K

標稱壓力 Working pressure marking16 kgf/cm²

120°C 以下之靜流水

Non shock water under 120°C14 kgf/cm²

220°C 以下之蒸汽、氣體、瓦斯、油、脈動水

Steam, Air, Gas, Oil, Pulse stream under 220°C12 kgf/cm²

300°C 以下之蒸汽、氣體、瓦斯、油、脈動水

Steam, Air, Gas, Oil, Pulse stream under 300°C10 kgf/cm²

※Teflon墊片最高使用溫度 180°C (356°F)

測試壓力 Test Pressure

閥體 Body	24 kgf/cm ² (Hydrostatic)
閥座 Seat	15 kgf/cm ² (Hydrostatic)
	6 kgf/cm ² (Air)

Parts and materials list

閥體 Body	FCD450
閥蓋 Bonnet	FCD450
閥桿 Stem	SUS410
閥門 Disc	SUS410/PTFE+15%G.F.T.
閥座 Seat Ring	SUS410
連結螺帽 Lock Nut	FCD450
墊片 Gasket	Non Asbestos
迫緊 Packing	Graphite
迫緊螺帽 Packing Nut	FCD450
把手 Handwheel	FCD450
銘牌 Name Plate	Aluminum

• Connection.....Flanged End (R.F)

Size	mm	15	20	25	32	40	50
	inch	1/2	3/4	1	1 1/4	1 1/2	2
L		108	117	127	140	165	203
H(open)		140	160	170	180	204	235
D1		80	100	100	120	140	140

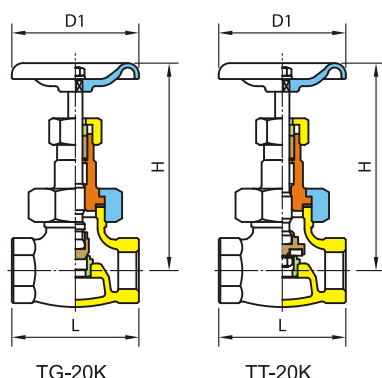
JIS-20K**球狀石墨鑄鐵球型閥
Ductile Iron Globe Valve****螺紋口
Screwed****TG-20K (SUS Disc)
TT-20K (Teflon Disc)**

標稱壓力 Working pressure marking20 kgf/cm²
 120°C以下之靜流水
 Non shock water under 120°C28 kgf/cm²
 220°C以下之蒸汽、氣體、瓦斯、油、脈動水
 Steam, Air, Gas, Oil, Pulse stream under 220°C25 kgf/cm²
 300°C以下之蒸汽、氣體、瓦斯、油、脈動水
 Steam, Air, Gas, Oil, Pulse stream under 300°C23 kgf/cm²
 350°C以下之蒸汽、氣體、瓦斯、油、脈動水
 Steam, Air, Gas, Oil, Pulse stream under 350°C20 kgf/cm²
 ※Teflon墊片最高使用溫度180°C (356°F)

測試壓力 Test Pressure

閥體 Body	44 kgf/cm ² (Hydrostatic)
閥座 Seat	32 kgf/cm ² (Hydrostatic)
	6 kgf/cm ² (Air)

Parts and materials list

閥體 Body	FCD450
閥蓋 Bonnet	FCD450
閥桿 Stem	SUS410
閥門 Disc	SUS410/PTFE+15%G.F.T.
閥座 Seat Ring	SUS410
連結螺帽 Lock Nut	FCD450
墊片 Gasket	Non Asbestos
迫緊 Packing	Graphite
迫緊螺帽 Packing Nut	FCD450
把手 Handwheel	FCD450

• Connection.....Screwed End (P.T)

Size	mm	15	20	25	32	40	50
	inch	½	¾	1	1¼	1½	2
L		75	90	105	120	135	160
H(open)		140	155	165	175	200	225
D1		80	100	120	120	140	180

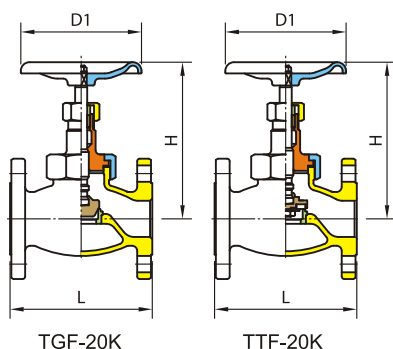
JIS-20K**球狀石墨鑄鐵球型閥
Ductile Iron Globe Valve****法蘭口
Flanged****TGF-20K (SUS Disc)
TTF-20K (Teflon Disc)**

標稱壓力 Working pressure marking20 kgf/cm²
 120°C以下之靜流水
 Non shock water under 120°C28 kgf/cm²
 220°C以下之蒸汽、氣體、瓦斯、油、脈動水
 Steam, Air, Gas, Oil, Pulse stream under 220°C25 kgf/cm²
 300°C以下之蒸汽、氣體、瓦斯、油、脈動水
 Steam, Air, Gas, Oil, Pulse stream under 300°C23 kgf/cm²
 350°C以下之蒸汽、氣體、瓦斯、油、脈動水
 Steam, Air, Gas, Oil, Pulse stream under 350°C20 kgf/cm²
 ※Teflon墊片最高使用溫度180°C (356°F)

測試壓力 Test Pressure

閥體 Body	44 kgf/cm ² (Hydrostatic)
閥座 Seat	32 kgf/cm ² (Hydrostatic)
	6 kgf/cm ² (Air)

Parts and materials list

閥體 Body	FCD450
閥蓋 Bonnet	FCD450
閥桿 Stem	SUS410
閥門 Disc	SUS410/PTFE+15%G.F.T.
閥座 Seat Ring	SUS410
連結螺帽 Lock Nut	FCD450
墊片 Gasket	Non Asbestos
迫緊 Packing	Graphite
迫緊螺帽 Packing Nut	FCD450
把手 Handwheel	FCD450

• Connection.....Flanged End (R.F)

Size	mm	15	20	25	32	40	50
	inch	½	¾	1	1¼	1½	2
L		110	120	130	160	180	230
H(open)		140	160	165	175	205	225
D1		80	100	120	120	140	180

JIS-10K

球狀石墨鑄鐵球型閥 Ductile Iron Globe Valve

法蘭口 Flanged

TGF-16K (SUS Disc) TTF-16K (Teflon Disc)

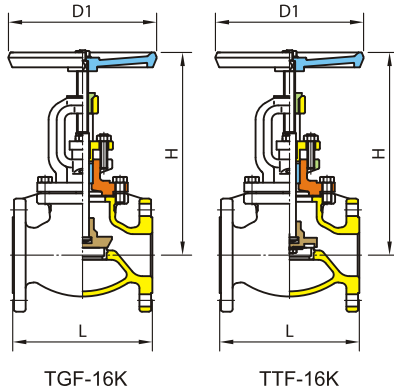

標稱壓力 Working pressure marking 16 kgf/cm²
 120°C 以下之靜流水
 Non shock water under 120°C 16 kgf/cm²
 220°C 以下之蒸汽、氣體、瓦斯、油、脈動水
 Steam, Air, Gas, Oil, Pulse stream under 220°C 12 kgf/cm²
 300°C 以下之蒸汽、氣體、瓦斯、油、脈動水
 Steam, Air, Gas, Oil, Pulse stream under 300°C 10 kgf/cm²
 ※ Teflon 墊片最高使用溫度 180°C (356°F)

測試壓力 Test Pressure

閥體 Body	24 kgf/cm ² (Hydrostatic)
閥座 Seat	15 kgf/cm ² (Hydrostatic)
	6 kgf/cm ² (Air)

Parts and materials list

閥體 Body	FCD450
閥蓋 Bonnet	FCD450
閥桿 Stem	SUS410
閥門 Disc	SUS410/PTFE+15%G.F.T.
閥座 Seat Ring	SUS410
墊片 Gasket	Non Asbestos
迫緊 Packing	Graphite
迫緊螺帽 Packing Nut	FCD450
把手 Handwheel	FCD450
銘牌 Name Plate	Aluminum

• Connection Flanged End (R.F)

Size	mm	65	80	100	125	150	200
	inch	2½	3	4	5	6	8
L		216	241	292	356	406	495
H(open)		330	385	420	485	485	590
D1		230	230	280	340	340	400

JIS-16K

球狀石墨鑄鐵由任式逆止閥 Ductile Iron Union Check Valve

螺紋口 Screwed

TUC-16K

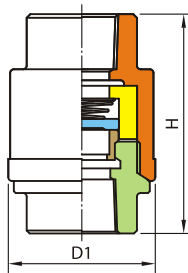

TUC-16K

標稱壓力 Working pressure marking 16 kgf/cm²
 120°C 以下之靜流水
 Non shock water under 120°C 16 kgf/cm²
 220°C 以下之蒸汽、氣體、瓦斯、油、脈動水
 Steam, Air, Gas, Oil, Pulse stream under 220°C 12 kgf/cm²

測試壓力 Test Pressure

閥體 Body	24 kgf/cm ² (Hydrostatic)
閥座 Seat	15 kgf/cm ² (Hydrostatic)
	6 kgf/cm ² (Air)

Parts and materials list

閥體 Body	FCD450
閥蓋 Cap	FCD450
閥門 Disc	SUS410
閥座 Seat Ring	SUS410
彈簧 Spring	SUS304
襯套 Sleeve	B62

• Connection Screwed End (P.T)

Size	mm	15	20	25	32	40	50
	inch	½	¾	1	1¼	1½	2
H		60	70	80	90	100	110
D1		41	48	56	72	86	102